

 **West Marine®**

VHF255

***Floating Dual Band
Two-Way Marine Radio
Radio maritime bidirectionnelle
à deux bandes***



***Owner's Manual
Guide d'utilisation***

Model / Modèle 12019113

Making a Distress Call

Speak slowly - clearly - calmly.

For future reference, write your boat's name & call sign here:

1. Make sure your radio is on.
2. On the radio, press the **16/9-Tri** button to switch to Channel 16 (156.8 MHz). (If the corner of the display does not show 16, press the **16/9-Tri** button again until it does.)
3. Press the **push to talk** button on the microphone and say: **"MAYDAY -- MAYDAY -- MAYDAY."**
4. Say **"THIS IS** *{name of your boat (three times) and call sign/boat registration number (once)}*."
5. Say **"MAYDAY** *{name or call sign of your boat}*."
6. Tell where you are: (what navigational aids or landmarks are near, or read the latitude and longitude from your GPS).
7. State the nature of your distress, (e.g. are you sinking, medical emergency, man overboard, on fire, adrift, etc.)
8. State the type of assistance you need (medical, towing, pumps, etc.).
9. Give number of persons aboard and conditions of any injured persons.
10. Estimate present seaworthiness of your ship (e.g. how immediate is the danger due to flooding or fire or proximity to shore).
11. Briefly describe your ship, giving the ship name (e.g. "Blue Duck is a 32 foot cabin cruiser, white hull, blue deck house").
12. Say: **"I WILL BE LISTENING ON CHANNEL 16."**
13. End message by saying **"THIS IS** *{name or call sign of your boat}*, **OVER."**
14. Release the **push to talk** button and listen.

If you do not get an answer after 30 seconds, repeat your call, beginning at step 3, above.

Faire un appel de détresse

Faire un appel de détresse vocal

Parlez lentement – clairement – calmement.

Pour toute référence ultérieure, transcrivez ci-dessous le nom et l'indicatif d'appel de votre bateau :

1. Vérifiez si votre radio est en marche.
2. Appuyez sur la touche **16/9-Tri** de la radio afin de commuter au canal 16 (156,8 MHz). (Si le canal 16 n'apparaît pas à l'affichage, appuyez de nouveau sur la touche **16/9-Tri** jusqu'à ce qu'il soit affiché.)
3. Appuyez sur le bouton de microphone **push to talk** et dites : "**MAYDAY - MAYDAY - MAYDAY**".
4. Donnez l'identité de votre navire en disant : "**ICI** {nom de votre bateau (trois fois) ou indicatif d'appel et le numéro d'identification de votre bateau (une fois)}".
5. Dites "**MAYDAY** {nom ou indicatif d'appel de votre bateau} une fois".
6. Donnez votre position : (quels sont les points de repère ou aides à la navigation près de vous ou lisez les coordonnées de longitude et de latitude apparaissant sur votre dispositif GPS).
7. Révélez la nature de votre détresse (par exemple, nous sommes en train de couler, urgence médicale, un homme à la mer, un incendie, nous sommes à la dérive, etc).
8. Révélez la nature de l'assistance désirée (médicale, remorquage, essence, etc.)
9. Donnez le nombre de personnes à bord et les conditions des blessés, s'il y en a.
10. Donnez la condition de navigabilité actuelle de votre navire, tel que le degré de l'urgence par rapport à l'inondation, à l'incendie ou à votre proximité de la côte.
11. Donnez une brève description de votre navire en donnant le nom du bateau (par exemple, "Blue Duck est un yacht de croisière de 32 pieds, avec une coque blanche et un rouffle bleu.").
12. Dites : "**JE VAIS ÉCOUTER SUR LE CANAL 16**".
13. Terminez le message en disant "**ICI** {nom ou indicatif d'appel de votre bateau}, **À VOUS**".
14. Relâchez le bouton **push to talk** du microphone et écoutez.

Si vous n'obtenez pas de réponse après 30 secondes, répétez l'appel en commençant à l'étape 3 ci-dessus.

Table of Contents

Making a Distress

Call (inside front cover)

Faire un appel de détresse vocal iii

Introduction..... E-1

Features E-1

Getting Started..... E-3

What's Included E-3

Parts of the VHF255 E-4

Front view.....E-4

Back viewE-4

ChargerE-6

Using the Menus..... E-6

Using Your Radio (General

Operation) E-6

Changing the VolumeE-6

Setting the Squelch LevelE-7

Changing the ChannelE-7

Contrast.....E-8

Lamp adjust.....E-8

Turning the Key Beep

On and OffE-9

Using the external

speaker/mic jackE-9

How It Works..... E-10

Normal mode operationE-11

Normal mode with

Weather Alert WatchE-12

Normal mode with Triple

Watch or Dual WatchE-12

Normal mode with

Quad WatchE-13

Scan mode operation E-13

Using the radio in
scan modeE-14

Scan mode with Weather
Alert Watch.....E-14

Scan mode with Triple
Watch or Dual WatchE-15

Both Weather Alert and Triple/
Dual Watch in scan mode ...E-15

Weather mode E-15

Using the radio in
weather modeE-16

Weather mode with
Weather Alert WatchE-16

Weather mode with Triple
Watch or Dual WatchE-16

Using the Marine VHF

Band..... E-17

Making a Transmission..... E-19

Boosting the transmission
powerE-19

Setting the UIC Channel
Mode E-20

Using the Strobe SOS Light ... E-20

Using the FRS/GMRS Band .. E-21

GMRS License E-21

FRS/GMRS Band Features ... E-21

Reading the FRS/GMRS
band screen..... E-22

FRS/GMRS band
menu optionsE-22

Setting CTCSS/DCS
privacy codesE-22

Setting Up the Hardware..... E-25

Installing the Battery E-25

| | |
|---------------------------------|-------------|
| Using the Alkaline Battery | |
| Case | E-25 |
| Mounting the Charger | E-27 |
| Charging the Battery | E-27 |
| Important notes on | |
| charging the battery | E-28 |
| Attaching the Belt Clip | E-28 |
| Maintenance and | |
| Troubleshooting | E-30 |
| Common Questions | E-30 |
| Specifications | E-32 |
| Regulations and Safety | |
| Warnings | E-43 |
| Three Year Limited | |
| Warranty Statement | E-46 |

Introduction

Features

Your radio provides the following key features:

Submersible design

Complies with floating JIS8/IPX8 water-resistant standards, which means the radio can be submerged in 1.5 meters of water for 30 minutes without damage.

- ◆ The radio will only meet this rating if fully assembled and all rubber seals and sealing plugs are well maintained and correctly fitted. This means that the speaker microphone is attached or the sealing plug is fitted, and the battery pack (or case) and antenna are attached and securely fastened.
- ◆ After your radio is submerged in water, you might notice that the sound is distorted. This is because there is still water remaining in and around the speaker and microphone. Just shake the radio to clear excess water, and the sound will return to normal.
- ◆ If your radio is exposed to salt water, clean it thoroughly with fresh water.
- ◆ The charging equipment is not waterproof.

Memory scan mode

Lets you save channels to memory and monitor them in quick succession.

Transmitter power level select

Lets you boost the transmitter power from 1 Watt to 2.5 or 5 Watts for added transmission distance.

Battery level icons and low battery alert

Dual, Triple and Quad Watch operation

These different watch modes let you monitor up to two Coast Guard Distress/Hailing channels and one weather channel along with one regular marine channel.

All marine VHF channels for the U.S., Canada, and international waters

FRS/GMRS radio modes

Lets you use your radio to keep in touch with other members of your party on shore or on another craft close by.

National Oceanic and Atmospheric Administration (NOAA) Weather Channel watch

Sounds a warning tone when a hazard alert is issued.

Getting Started

What's Included



VHF255 Radio
with Antenna



Charging Cradle
12012589



Screws for
Charging Cradle



AC-DC Charging
Adapter
12012571

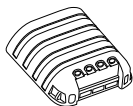

Lithium Ion Battery
12012555



DC Charging
Adapter
12012563



Alkaline Battery Tray
(batteries not included)
12303038



Wrist Strap
12012548



Belt Clip
7830458

If any pieces are missing or damaged, contact West Marine (see back cover for contact information).

Parts of the VHF255

Front view



Back view

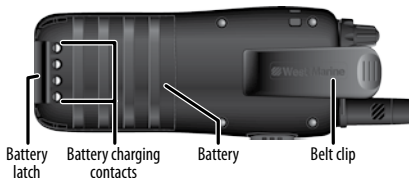

| Knob | Turn clockwise to... | Turn counter-clockwise to... |
|----------------------------|--|---|
| <i>Squelch</i> | Raise the squelch level to reduce channel noise. | Lower the squelch level to hear weaker signals. |
| <i>Volume-Power</i> | Turn on the radio or increase the volume. | Decrease the volume or turn off the radio. |

| Button | Press to... | Press and hold to... |
|--------------------------------|--|--|
| <i>Push to talk</i> | NA | Transmit on a channel |
| <i>Channel up</i> | Move up one channel at a time. | Move quickly up the channels. |
| <i>16/9 - TRI (Red)</i> | 1st press: Go to channel 16. 2nd press: Go to channel 9. 3rd press: Go back to the starting channel. | Turn Triple Watch on and off. |
| <i>MENU</i> | Access the radio menus. | NA |
| <i>ENTER - LOCK</i> | <ul style="list-style-type: none"> - Select menu items. - Return to normal marine VHF screen while marine channel list is displayed. | Lock the keys; press and hold again to unlock. |
| <i>WX - ALERT</i> | Listen to the weather channels or return to the last channel of the previous radio band. | Turn Weather Alert Watch on and off. |
| <i>SCAN - MEM</i> | Enter or exit SCAN mode. | Store the current working channel into memory. |
| <i>BAND - 1/2.5/5W</i> | Switch the band between VHF and FRS/GMRS. | Change the transmit power (see page E-11). |

| Button | Press to... | Press and hold to... |
|---------------------|----------------------------------|---------------------------------|
| Channel down | Move down one channel at a time. | Move quickly down the channels. |

Charger

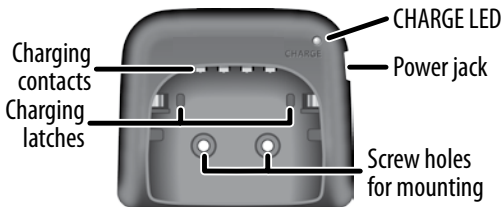

Using the Menus

Here are some general hints on operating the VHF255 menu screens.

- ◆ The current item is highlighted in reversed out text.
- ◆ Use **Channel up** to move up a line in the menu.
- ◆ Use **Channel down** to move down a line in the menu.
- ◆ Press **ENTER - LOCK** to choose the selected item.
- ◆ Select **Exit** to close the menu

Using Your Radio (General Operation)

Changing the Volume

To increase the speaker volume, turn the **Volume-Power** knob clockwise; turn it counter-clockwise to decrease the volume.

Setting the Squelch Level

The squelch feature reduces static on the speaker by filtering out any background channel noise. At the lowest squelch level, the speaker plays all signals, including any channel noise. Setting the squelch level higher filters out noise and lets only actual radio transmissions through.

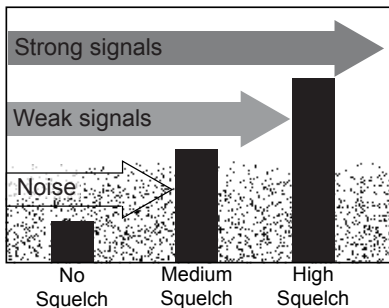

While listening to a channel, adjust the **SQUELCH** knob until the noise is filtered and you can hear only the transmission. If you switch to a channel with a lot of noise or a weak transmission, you may need to readjust the squelch level again.

 **Setting the squelch level too high may prevent you from hearing weaker transmissions. If you are having difficulty hearing a transmission, try setting the squelch level lower.**

Changing the Channel

Press **Channel up** and **Channel down** briefly to scroll through the channels one channel at a time. Press and hold **Channel up** or **Channel down** to quickly scroll through the channels.

Contrast

The display has 10 levels of contrast for each LCD display format: light letters on a dark background or dark letters on a light background. Scrolling from 1 to zero switches the contrast. To adjust the contrast:

- 1) Press the **MENU** button and select *Contrast/RVS*.
- 2) Use **Channel up** and **Channel down** to change the contrast to your desired level.
- 3) Press **ENTER** to set the new contrast level and exit the menu.

Lamp adjust

The LCD and keypad light up whenever you press a key on the radio; the backlight stays on for 5 seconds and then turns off automatically. You can change the amount of time the LCD and keypad backlight stays on.

- 1) Press the **MENU** button and choose *Lamp Adjust*.
- 2) Choose how you want the backlight to operate:
 - ◆ *Always On* makes the backlight stay on.
 - ◆ *Always Off* makes the backlight never come on
 - ◆ *Timer* makes the backlight stay on for a set amount of time after you press a key.
 - ◆ *Color* lets you select green or orange background.
- 3) If you select *Timer*, the radio prompts you to choose the amount of time you want the backlight to stay on. Choose from *5 seconds*, *10 seconds* (default), *30 Seconds*, *1 Minute*, or *5 Minutes*.
- 4) Press **ENTER** to save the new setting.

Turning the Key Beep On and Off

Key beep is the tone that sounds when you press a key or a button. You can turn this tone on and off by using the *Key Beep* menu.

1. From the *Main* menu, select *Key Beep*; press **ENTER - LOCK** to display the *Key Beep* screen.
2. Select *ON* or *OFF* and press **ENTER - LOCK**. The radio returns to the *Marine Main* menu.
3. Press **MENU** to return to the main screen.

Using the external speaker/mic jack

You can connect an optional external speaker-mic (SM81 - part number 12012597) to this watertight jack. Unscrew the cap, which is held by the rubber cap-keeper to prevent loss. Insert the special gasketed plug and screw down the shell, which prevents water from entering the jack.

For details, consult your West Marine dealer or contact West Marine directly (see back cover for contact information).

How It Works

Your radio has three main operation modes: normal, scan, and weather.

| Mode | What it does | Use it when you want to... | To turn it on/off |
|---------|---|---|---------------------------|
| Normal | Monitors a single marine channel and lets you talk on that channel. | Monitor a channel or talk to another radio. | (default mode) |
| Scan | Monitors all the channels you save into memory. | Check a small group of regularly-used channels for traffic. | Press SCAN - MEM . |
| Weather | Monitors the selected NOAA weather channel. | Hear the current or forecasted weather. | Press WX-ALERT . |

In addition to the three operation modes, your radio provides four different *watch modes* which you can activate during any operation mode. In the watch modes, the radio briefly checks for activity on a specific channel, then returns to its previous operation.

| Watch mode | What it does | To turn it on/off |
|---------------------|---|--|
| Weather Alert Watch | Checks the last-used weather channel for hazard alerts every 7 seconds. | Press and hold WX-ALERT for 2 seconds. |
| Dual Watch | Checks channel 16 for activity every 2 seconds. | Press and hold SCAN - MEM for 2 seconds. |
| Triple Watch | Checks channels 16 and 9 for activity every 2 seconds. | Press and hold BAND - 16/9-TRI for 2 seconds. |

| Watch mode | What it does | To turn it on/off |
|------------|--|---|
| Quad Watch | Checks channels 16 and 9 for activity every 2 seconds, and checks the last-used weather channel every 7 seconds. | Turn on Triple Watch, then turn on Weather Alert Watch. |

 **Private boats must monitor channel 16 whenever they are underway. Water-going vessels should have either Triple Watch or Dual Watch on at all times.**

Normal mode operation

- ◆ To transmit, remove the radio from the charger, then press and hold **Push to talk**. Release the button when you are finished talking.
- ◆ For the best sound quality, hold the microphone about two inches from your mouth while you're talking.
- ◆ Press **Channel up** to move up one channel at a time. Press and hold the button to scroll quickly up the channels.
- ◆ Press **Channel down** to move down one channel at a time. Press and hold the button to scroll quickly down the channels.
- ◆ To change the transmit power, press **BAND - 1/2.5/5W**. The transmit power switches to the next transmit power each time you press this button.

Normal mode with Weather Alert Watch

If you activate Weather Alert Watch while operating in

normal mode, the radio checks the most recently used weather channel every seven seconds. If it detects a weather or other hazard alert, it will switch to that weather channel. (If you are actively transmitting, the radio waits until you finish your transmission before checking the weather channel.)

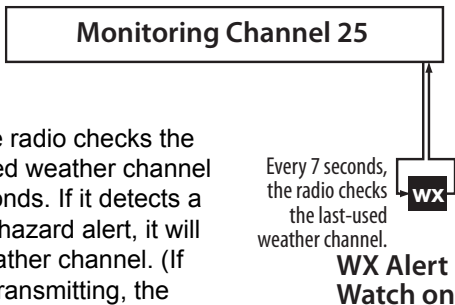

Normal mode with Triple Watch or Dual Watch

If you activate Triple Watch while operating in normal mode, the radio checks channels 16 and 9 every two seconds; with Dual Watch turned on, the radio only checks channel 16. The radio will not check channels 16 or 9 while you are actively transmitting; it waits until your transmission is finished and then checks the channels.

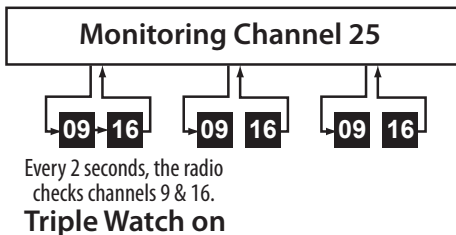

Normal mode with Quad Watch

You can activate Weather Alert Watch and Triple Watch at the same time to monitor four channels at once (Quad Watch). The radio performs the Triple Watch and Weather Alert Watch checks at their scheduled time.

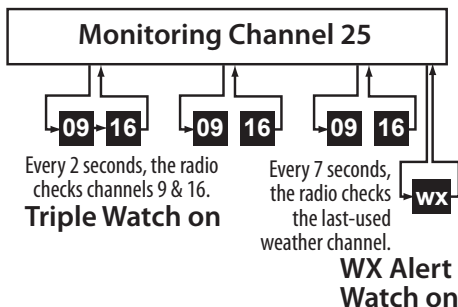

Scan mode operation

You can save channels into memory and then use scan mode to monitor those channels from lowest to highest. If the radio detects a signal on a channel, it stays on that channel as long as the signal is received; when the signal stops, the radio continues scanning.

When it detects a signal, the radio stays on the channel until you press the *Channel Up* button or the signal stops.

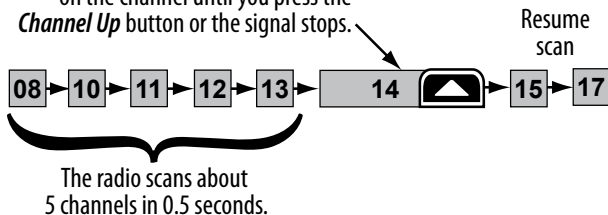

Using the radio in scan mode

- ◆ To activate scan mode, press **SCAN - MEM**.
- ◆ You must have at least two channels in memory to start a scan.
- ◆ You cannot transmit while in scan mode.
- ◆ To save a channel into memory, select the channel, then press and hold **SCAN-MEM**. **MEMORY** displays whenever you tune to that channel.
- ◆ To remove a channel from memory, set the radio to that channel, then press and hold **SCAN-MEM** again. **MEMORY** no longer displays.
- ◆ When the radio stays on a channel, press **SCAN - MEM** to leave that channel and resume scanning.
- ◆ To stop scanning, press the **SCAN - MEM** button again; the radio remains on the last scanned channel.

Scan mode with Weather Alert Watch

If you activate Weather Alert Watch while in scan mode, the radio checks the most recently-used weather channel every seven seconds, then continues scanning the next channel in memory:

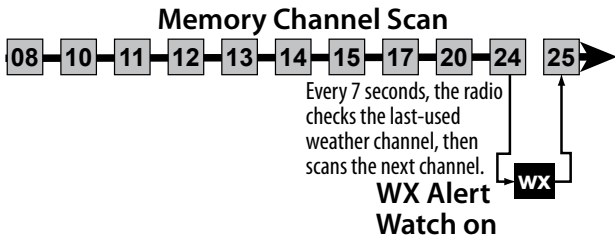

Scan mode with Triple Watch or Dual Watch

If you activate Triple Watch while operating in scan mode, the radio checks channels 16 and 9 every two seconds, then goes on to scan the next channel; with Dual Watch turned on, the radio only checks channel 16:

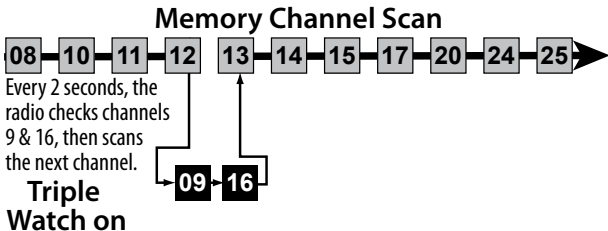

Both Weather Alert and Triple/Dual Watch in scan mode

You can activate Weather Alert Watch and Triple/Dual Watch at the same time. The radio performs both checks at their scheduled time:

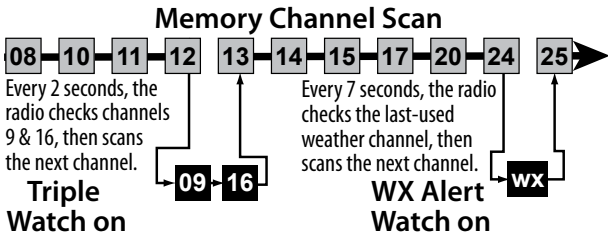

Weather mode

The NOAA weather channels now cooperate with the FCC to alert you of other hazards besides weather (child abduction alerts, nuclear, biological, etc.). In weather

mode, the radio monitors one of the ten NOAA weather channels. If any type of alert is received, the radio sounds an alert tone and the display blinks.

Using the radio in weather mode

- ◆ You cannot transmit while in weather mode.
- ◆ To enter weather mode, press the **WX - ALERT** button.
- ◆ To turn off the radio's alert tone, press any button.
- ◆ To cancel weather mode and return to the previous marine channel, press the **WX - ALERT** button again.

Weather mode with Weather Alert Watch

Because weather mode already monitors the weather channels, you don't need Weather Alert Watch to check the weather channel every seven seconds. If you activate Weather Alert Watch while operating in weather mode, it operates as a type of "sleep mode:" the radio stays on the weather channel and mutes the speaker. If an alert is detected, the radio sounds an alert tone and turns the speaker back on. This mode is very useful when you are anchoring for the night but want to keep informed of hazards.

Weather mode with Triple Watch or Dual Watch

If you activate Triple Watch while operating in weather mode, the radio checks channels 16 and 9 every two seconds; with Dual Watch turned on, the radio only checks channel 16.

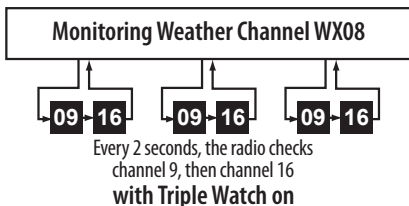

Using the Marine VHF Band

The following features and options are available only when the radio is in the marine VHF band. Press **BAND - 1/2.5/5W** until the display shows VHF.



Reading the marine band screen

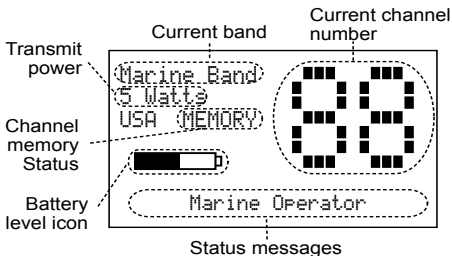

Marine band menu options

Follow the steps below to open the marine band menu:

- 1) If the top of the display does not show *Marine Band*, press the **BAND-1/2.5/5W** button until *VHF* displays.
- 2) Wait for the display to show the marine band screen, then press the **MENU** button.
- 3) Refer to the table below for the available options and settings available in the marine band.

| Menu Option | Use It To... | Available Settings (default setting in italics) |
|------------------------------|---|---|
| <i>USA/ CAN/ INT</i> | Change the channel mode from US to Canadian or International channels | <i>USA Mode</i> <i>CAN</i> adian Mode <i>INT</i> ernational Mode |
| <i>SOS Light</i> | Turn the strobe light on or off. | Always on <i>Strobe SOS</i> Off |
| <i>Lamp Adjust</i> | Change the operation and color of the display backlight | Always On <i>Timer</i> (see page 22 for details) Always Off Color |
| <i>Contrast/ RVS.</i> | Adjust the display contrast | 10 contrast levels (<i>default = 7</i>) |
| <i>Dual/ TriWatch</i> | Choose between triple watch and dual watch | <i>16/9 TriWatch</i> 16 DualWatch |
| <i>Key Beep</i> | Turn the key touch tones on or off | <i>On</i> Off |
| <i>FIPS Codes</i> | Enter or edit the six-digit codes for the geographic areas whose hazard alerts you want to listen to. | <i>No FIPS codes entered.</i> See page 28 for instructions on entering FIPS codes. |
| <i>Channel Name</i> | Change the name displayed for a channel or reset channel names back to their default settings | <i>See the tables starting on page 42 for default channel names.</i> See page 27 for instructions on changing channel names. |
| <i>Exit</i> | Close the menu | |

- ◆ See the tables starting on page 42 for a list of receive-only channels.

Making a Transmission

Select the channel you want to transmit on, then press and hold **Push to talk**. Release **Push to talk** when you're finished talking to let the other party respond.

- ◆ To prevent stuck microphone problems or situations where **Push to talk** is pushed accidentally, the radio limits your talk time to 5 minutes in a single transmission.
- ◆ For the best sound quality, hold the microphone about two inches away from your mouth.
- ◆ See the channel lists starting on page E-34 for a list of receive-only channels.

Boosting the transmission power

In most situations, the 1 Watt transmission power is all you need. If you find yourself far away from other stations and have trouble getting a response, you may need to boost the transmission power from 1 Watt to 2.5 Watts or 5 Watts:

- 1) Select the channel you want to transmit on.
 - 2) Press and hold **BAND - 1/2.5/5W** to switch to the next transmission power level (for example, from 5 Watt to 2.5 Watts; from 2.5 Watts to 1 Watt, or from 1 Watt back around to 5 Watts).
 - 3) The display shows the new transmission power in the lower left hand corner. The transmit power remains at the new setting until you change it again.
-  **Don't forget to change the transmission setting back to 1 Watt when you move close to other stations.**

Some channels (for example, channels 13 and 67) limit the transmission power to 1 Watt. When you tune to a limited-power channel, the radio automatically switches to 1 Watt. See the channel lists starting on page E-34 for a list of power-restricted channels.

Setting the UIC Channel Mode

The radio is preset to US-assigned channels. Follow these steps to change the channel mode to Canadian or international channel assignments,

1. Open the menu and select *USA/CAN/INT*; press **ENTER - LOCK**.
2. Scroll up or down to select the UIC channel mode desired; press **ENTER - LOCK**.
3. The radio beeps twice and returns to the *Marine Menu* screen. Press **MENU** to return to the *Main* screen.

Using the Strobe SOS Light

You can use this radio in an emergency. If you turn on the strobe SOS high-intensity LED light on your radio, your radio will blink “S O S” in international Morse Code. This will make it easier for rescuers to find you faster. You can also select a continuous light instead of the SOS pattern.

 **Your radio operates normally when the SOS LED strobe is activated.**

1. From the radio's Main menu, select SOS Light and press **ENTER - LOCK**.
2. Scroll up or down to select *Always On*, *Strobe*, or *Off*. Press **ENTER - LOCK**. The *Marine Main* menu displays.
3. Press **MENU** to return to the main screen.

Using the FRS/GMRS Band

GMRS License

The VHF255 can operate on the General Mobile Radio Service (GMRS) frequencies. You must have a GMRS license issued by the Federal Communications Commission to legally use GMRS channels. For licensing information and application forms, visit the FCC online at: www.fcc.gov/wtb/uls or call the FCC Hotline at 1-800-418-3676. If you have any questions, you can contact the FCC directly at 1-888-255-5322. No license is required for operation on non-GMRS channels or operation on any channel in Canada.

FRS/GMRS Band Features

The following features and options are available only when the radio is in the FRS/GMRS band. To activate this band, press the **BAND-1/2.5/5W** button; the display shows *FRS/GMRS*.



FRS/GMRS

Reading the FRS/GMRS band screen

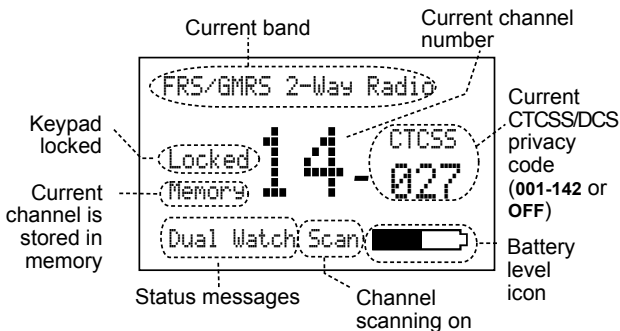

FRS/GMRS band menu options

There are two differences between the Marine VHF band and FRS/GMRS band menus:

- ♦ *USA/CAN/INT*, *FIPS Codes*, and *Channel Name* menus appear on the Marine VHF band menu but not the FRS/GMRS menu.
- ♦ *CTCSS* appears on the FRS/GMRS band menu but not the Marine VHF band menu.

The other menu options are identical.

Setting CTCSS/DCS privacy codes

Normally, any FRS/GMRS radio that is within range and using the same channel can hear FRS/GMRS conversations. To prevent other radios from hearing you or to reduce interference with other radios, you can enable one of the 142 privacy codes for any channel. Only radios that have the matching privacy code will be able to decipher your transmission.

 Privacy codes are specific to each channel. Make sure the person you want to communicate with has the same code set on the same channel you do.

1) Open the *FRS/GMRS* menu. Select *CODE* and press *ENTER-LOCK*.

2) The current *FRS/GMRS* channel is highlighted. Use the *Channel up* or *Channel down* button to select a different channel. Any channel that has a privacy code enabled has an asterisk in the display.

3) Choose *On* to enable a privacy code on this channel or choose *Off* to disable a previously-set code.

4) Enter a code number between 001 and 142. Use the *Channel up* and *Channel down* buttons to change the first digit; the *Channel up* button increases the number; the *Channel down* button decreases the number.

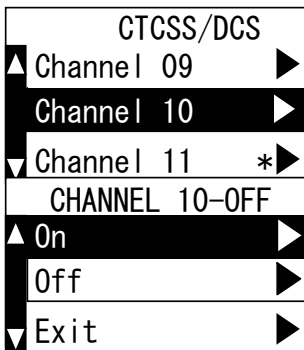

Press the UP or DOWN arrow keys to select the character then press the enter key

0 _ _

- 5) When the first digit is correct, press the **ENTER-LOCK** button to move to the next digit. Enter the remaining two digits of the code in the same way.

 **Note:** If you try to enter a code number less than 001 or greater than 142, an error tone sounds.

When the third digit is correct, press **ENTER-LOCK**. The screen displays the channel along with the chosen code number. If you want to change the code, select *Edit*.

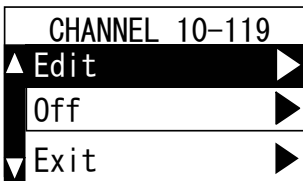

- 6) Select *Exit* to save the settings and exit the menu.

Setting Up the Hardware

Installing the Battery

Your radio comes with a rechargeable Lithium Ion battery; for shipping safety, the battery is not installed at the factory. The empty alkaline battery case is installed as a placeholder.

- 1) Insert the tabs on the battery into the notches at the top of the battery compartment.

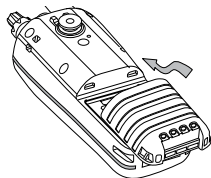

-  **Each time you remove the battery, check the rubber seal around the battery compartment. Make sure the seal is seated in the groove and there is no dirt or debris on it. If the seal looks worn or damaged, contact customer service to order a replacement (SKU# 12012555; see back cover page for contact information).**

- 2) Lower the battery until it rests flat in the compartment.
- 3) Bring the battery latch up and snap it into place.

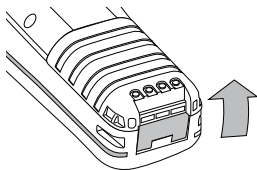

Using the Alkaline Battery Case

The radio also comes with a battery case that holds four AAA-type alkaline batteries (not included). You can use alkaline batteries as a backup for the Li-Ion battery so you can still use your radio while your Li-Ion battery is recharging. For best performance, West Marine

recommends using extra-strength alkaline batteries such as Duracell Ultra® batteries.

✎ When using alkaline batteries, transmit power is limited to a maximum of 2.5W.

Follow these steps to use the alkaline battery case:

- 1) Hold the lower part of the case in one hand with the three battery contacts facing down. Use your thumb to hold the notch on the lower part of the case.

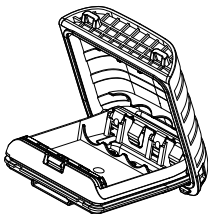

- 2) With your other hand, grip the upper part of the case and lift the cover open.

- 3) Align the batteries' positive and negative terminals with the drawing on the case and snap each battery into place.

- 4) Insert the two hooks on the lower part of the case into the notches on the cover; close the cover. (The cover fits snugly but you should not have to force it closed.)

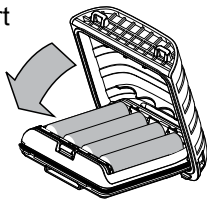

✎ Each time you open the battery case, check the rubber seal. Make sure the seal is seated in the groove and there is no dirt or debris on it. If the rubber seal looks worn or damaged, contact customer service to order a replacement (SKU# 12303038; see the back cover page for contact information).

- 5) Install the alkaline battery case in your radio just as you do the Li-Ion battery (see page E-15).

WARNING! The case is designed to prevent the accidental charging of alkaline batteries. Never use alkaline batteries in the radio without the case. Do not try to modify the battery case.

Mounting the Charger

You can mount the charger on any flat surface.

- 1) Use the two holes at the base of the charger as a template to mark the drill holes.
- 2) Using a 1/8-inch (or 3 mm) drill bit, drill two holes 1/2 inch (13mm) deep.
- 3) Use the provided screws to attach the charger to the surface.

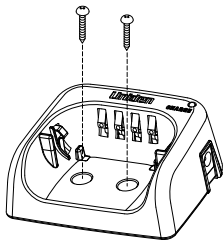

Charging the Battery

Your radio includes a charger and a rechargeable battery pack. Place your radio in the charger with the display facing forward. Make sure that the CHARGE LED on the charger turns orange.

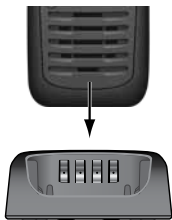

 **Make sure to turn the radio OFF before placing it in the charging cradle**

Cautions:

- ◆ **Use only the battery and charger supplied with this radio. Using a different charger or battery can damage the radio and create a risk of fire or shock.**

- ◆ The charger is not waterproof. If the charger falls into the water, unplug it before attempting to remove it from the water. After you remove the charger from the water, please contact Customer Service (see the back cover page for contact information).
- ◆ Wipe off dirt or shake water from your radio before placing in the charger if your radio gets dirty or wet.

Important notes on charging the battery

- ◆ Charge the battery fully before using the radio. When the battery is completely charged, the CHARGE LED on the charger turns green.
- ◆ Don't use the charger when the ambient temperature is below 0° C (32° F) or above 45° C (113° F).
- ◆ If the radio is powered down, the battery can charge in about seven hours. (If the radio is powered on, the battery takes longer to charge.)

Attaching the Belt Clip

To attach the belt clip:

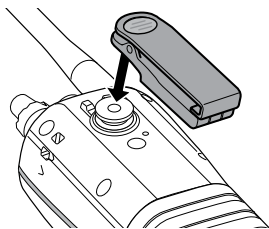

- 1) Rotate the belt clip so that the finger indentation is towards the top of the radio.
- 2) Align the center of the clip with the anchor post.

- 3) Place the clip on the post and slide the clip upwards until it clicks into place.

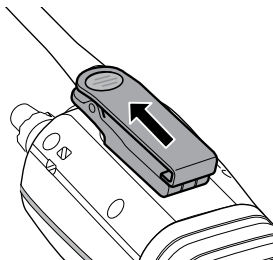

To remove the belt clip:

- 1) Rotate the clip so that the finger indentation is towards the bottom of the radio.

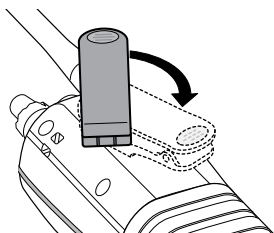

- 2) Slide the clip up until it comes free of the anchor post.

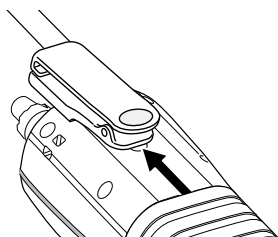

Maintenance and Troubleshooting

Due to its rugged design, your radio requires very little maintenance. However, it is a precision electronic instrument, so you should follow a few precautions:

- ◆ If the antenna has been damaged, do not transmit except in an emergency situation. Transmitting with a defective antenna may cause further radio damage.
- ◆ You are responsible for continued FCC technical compliance of your radio.

Common Questions

| Problem | Things to Try |
|---|--|
| The radio won't turn on. | Charge the radio. |
| The power LED on the charger doesn't turn on. | <ul style="list-style-type: none">– Don't use the charger when the ambient temperature is below 0° C (32° F) or above 45° C (113° F).– Make sure the charging contacts on the radio and charger are clean.– Replace the battery. |
| The radio won't transmit. | <p>Make sure you are not in weather or scan mode.</p> <p>Make sure you are not trying to transmit on a receive-only channel or transmit at the wrong power level for this channel (see the channel lists starting on page E-34).</p> <p>Check the battery power level; if it's low, charge the battery before trying to transmit.</p> <p>Make sure the duration of each transmission is less than 5 minutes.</p> |

| Problem | Things to Try |
|---|---|
| I can't hear anything from the speaker. | Adjust the squelch level; it is probably too high. |
| The sound is muffled or the volume is low. | Clear water from the speaker grill. |
| Noise comes out of the speaker all the time | Adjust the squelch level; it is probably too low. |
| I can transmit, but no one can hear me. | Check your UIC channel settings: does the area you are in use different channel assignments? |
| I'm not getting hazard alerts. | Make sure Weather Alert Watch is turned on. |
| The display flashes, and I don't know why. | The channel number on the display will flash if the radio is in a watch mode or in scan mode. Try turning off scanning, Weather Alert Watch, Triple Watch, or Dual Watch (see page E-10). |
| Where can I find my radio's serial number? | The serial number is on a plate inside the battery compartment. |

Specifications

| General | | |
|------------------------|---|-----------------|
| Channels | All US/International/Canada marine channels, FRS/GMRS channels | |
| | 10 Weather channels | |
| Freq. Control | PLL | |
| Freq. Tol. | Transmit: 1.5 PPM (at 25°C) | |
| | Receive: 1.5 PPM (at 25°C) | |
| Oper. Temp. | -4°F (-20°C) to +122°F(+50°C) | |
| Antenna | Flexible Whip | |
| Microphone | Built-in Electret type | |
| Display | Liquid Crystal Display | |
| Speaker | 8Ω 0.5 Watt | |
| Power Source | Rechargeable Lithium Ion Battery 7.4V 1040 mAh | |
| Size (without antenna) | 5.95 (H) x 2.56 (W) x 1.77 (D) inch 151 (H) x 65 (W) x 45 (D) mm | |
| Weight | 11.29 oz (320g) (w/battery and antenna) | |
| Transmitter | | |
| | Marine | FRS/GMRS |
| Frequency Range | 156~158 MHz | 462~467 MHz |
| Frequency Stability | ±10 PPM | ±2.5 PPM |
| Power Output | 5 W & 2.5W & 1W | 0.4W |
| Spurious Emissions | 70 dBm | -30 dBm |
| Current Drain | 1500 mA (5W) | 700 mA |
| Receiver | | |
| | Marine | FRS/GMRS |

| | | |
|--------------------------|--|--------------|
| Type | Double Conversion Super Heterodyne Phase Locked Loop system for Local Oscillator | |
| Frequency Range | 156~164 MHz | 462~467 MHz |
| Sensitivity (12dB SINAD) | 0.18 μ V | 0.25 μ V |
| Audio Frequency Response | +4.5 dB @ 500 Hz; -6 dB @ 2000Hz | |
| Audio Output Power | 0.35 W @10% THD | |
| Current Drain | Squelched: 70 mA; Max. Audio: 200 mA | |

Channels and Frequencies (MHz)

US channel frequencies and names

| US Marine Channels | | | | |
|--------------------|---------|---------|--------------|----------------------------------|
| Ch | RX Freq | TX Freq | Status | Name |
| 1A | 156.050 | 156.050 | Simplex | Vessel traffic system/commercial |
| 5A | 156.250 | 156.250 | Simplex | Vessel traffic system/commercial |
| 6 | 156.300 | 156.300 | Simplex | Inter-ship safety |
| 7A | 156.350 | 156.350 | Simplex | Commercial |
| 8 | 156.400 | 156.400 | Simplex | Commercial |
| 9 | 156.450 | 156.450 | Simplex | Non commercial |
| 10 | 156.500 | 156.500 | Simplex | Commercial |
| 11 | 156.550 | 156.550 | Simplex | Vessel traffic system |
| 12 | 156.600 | 156.600 | Simplex | Vessel traffic system |
| 13 | 156.650 | 156.650 | Simplex, 1W | Bridge to bridge |
| 14 | 156.700 | 156.700 | Simplex | Vessel traffic system |
| 15 | 156.750 | Inhibit | Receive only | Environmental |
| 16 | 156.800 | 156.800 | Simplex | Distress, safety, and calling |
| 17 | 156.850 | 156.850 | Simplex, 1W | Govt maritime control |
| 18A | 156.900 | 156.900 | Simplex | Commercial |

US Marine Channels

| Ch | RX Freq | TX Freq | Status | Name |
|-----|---------|---------|--------------|----------------------------|
| 19A | 156.950 | 156.950 | Simplex | Commercial |
| 20 | 161.600 | 157.000 | Duplex | Port operation |
| 20A | 157.000 | 157.000 | Simplex | Port operation |
| 21A | 157.050 | 157.050 | Simplex | Coast guard only |
| 22A | 157.100 | 157.100 | Simplex | Coast guard |
| 23A | 157.150 | 157.150 | Simplex | Coast guard only |
| 24 | 161.800 | 157.200 | Duplex | Marine operator |
| 25 | 161.850 | 157.250 | Duplex | Marine operator |
| 26 | 161.900 | 157.300 | Duplex | Marine operator |
| 27 | 161.950 | 157.350 | Duplex | Marine operator |
| 28 | 162.000 | 157.400 | Duplex | Marine operator |
| 63A | 156.175 | 156.175 | Simplex | Vessel traffic system |
| 65A | 156.275 | 156.275 | Simplex | Port operation |
| 66A | 156.325 | 156.325 | Simplex | Port operation |
| 67 | 156.375 | 156.375 | Simplex, 1W | Bridge To Bridge |
| 68 | 156.425 | 156.425 | Simplex | Non Commercial |
| 69 | 156.475 | 156.475 | Simplex | Non Commercial |
| 70 | 156.525 | Inhibit | Receive only | Digital Selective Calling |
| 71 | 156.575 | 156.575 | Simplex | Non Commercial |
| 72 | 156.625 | 156.625 | Simplex | Non Commercial (Ship-Ship) |
| 73 | 156.675 | 156.675 | Simplex | Port Operation |
| 74 | 156.725 | 156.725 | Simplex | Port Operation |
| 75 | 156.775 | 156.775 | Simplex, 1W | Port Operation |
| 76 | 156.825 | 156.825 | Simplex, 1W | Port Operation |
| 77 | 156.875 | 156.875 | Simplex, 1W | Port Operation (Ship-Ship) |
| 78A | 156.925 | 156.925 | Simplex | Non Commercial |
| 79A | 156.975 | 156.975 | Simplex | Commercial |
| 80A | 157.025 | 157.025 | Simplex | Commercial |
| 81A | 157.075 | 157.075 | Simplex | Coast Guard |
| 82A | 157.125 | 157.125 | Simplex | Coast Guard |
| 83A | 157.175 | 157.175 | Simplex | Government |

| US Marine Channels | | | | |
|---------------------------|----------------|----------------|---------------|------------------------|
| Ch | RX Freq | TX Freq | Status | Name |
| 84 | 161.825 | 157.225 | Duplex | Marine Operator |
| 85 | 161.875 | 157.275 | Duplex | Marine Operator |
| 86 | 161.925 | 157.325 | Duplex | Marine Operator |
| 87 | 157.375 | 157.375 | Simplex | Marine Operator |
| 88 | 157.425 | 157.425 | Simplex | Commercial (Ship-Ship) |

Canadian channel frequencies and names

| Canadian Marine Channels | | | | |
|---------------------------------|----------------|----------------|---------------|---------------------------|
| Ch | RX Freq | TX Freq | Status | Name |
| 1 | 160.650 | 156.050 | Duplex | Marine Operator |
| 2 | 160.700 | 156.100 | Duplex | Marine Operator |
| 3 | 160.750 | 156.150 | Duplex | Marine Operator |
| 4A | 156.200 | 156.200 | Simplex | Canadian Coast Guard |
| 5A | 156.250 | 156.250 | Simplex | Vessel Traffic System |
| 6 | 156.300 | 156.300 | Simplex | Inter-Ship Safety |
| 7A | 156.350 | 156.350 | Simplex | Commercial |
| 8 | 156.400 | 156.400 | Simplex | Commercial |
| 9 | 156.450 | 156.450 | Simplex | Boater Calling Channel |
| 10 | 156.500 | 156.500 | Simplex | Commercial |
| 11 | 156.550 | 156.550 | Simplex | Vessel Traffic System |
| 12 | 156.600 | 156.600 | Simplex | Vessel Traffic System |
| 13 | 156.650 | 156.650 | Simplex, 1W | Bridge To Bridge |
| 14 | 156.700 | 156.700 | Simplex | Vessel Traffic System |
| 15 | 156.750 | 156.750 | Simplex, 1W | Environmental |
| 16 | 156.800 | 156.800 | Simplex | Distress, safety, calling |
| 17 | 156.850 | 156.850 | Simplex, 1W | State Control |
| 18A | 156.900 | 156.900 | Simplex | Commercial |
| 19A | 156.950 | 156.950 | Simplex | Canadian Coast Guard |
| 20 | 161.600 | 157.000 | Duplex, 1W | Port Operation |

| Canadian Marine Channels | | | | |
|---------------------------------|----------------|----------------|---------------|---------------------------|
| Ch | RX Freq | TX Freq | Status | Name |
| 21A | 157.050 | 157.050 | Simplex | Canadian Coast Guard |
| 22A | 157.100 | 157.100 | Simplex | Canadian Coast Guard |
| 23 | 161.750 | 157.150 | Duplex | Canadian Coast Guard |
| 24 | 161.800 | 157.200 | Duplex | Marine Operator |
| 25 | 161.850 | 157.250 | Duplex | Marine Operator |
| 26 | 161.900 | 157.300 | Duplex | Marine Operator |
| 27 | 161.950 | 157.350 | Duplex | Marine Operator |
| 28 | 162.000 | 157.400 | Duplex | Marine Operator |
| 60 | 160.625 | 156.025 | Duplex | Marine Operator |
| 61A | 156.075 | 156.075 | Simplex | Canadian Coast Guard |
| 62A | 156.125 | 156.125 | Simplex | Canadian Coast Guard |
| 63A | 156.175 | 156.175 | Simplex | Port Operation |
| 64 | 160.825 | 156.225 | Duplex | Marine Operator |
| 64A | 156.225 | 156.225 | Simplex | Port Operation |
| 65A | 156.275 | 156.275 | Simplex | Port Operation |
| 66A | 156.325 | 156.325 | Simplex, 1W | Port Operation |
| 67 | 156.375 | 156.375 | Simplex | Bridge To Bridge |
| 68 | 156.425 | 156.425 | Simplex | Non Commercial |
| 69 | 156.475 | 156.475 | Simplex | Non Commercial |
| 70 | 156.525 | Inhibit | Receive only | Digital Selective Calling |
| 71 | 156.575 | 156.575 | Simplex | Non Commercial |
| 72 | 156.625 | 156.625 | Simplex | Non Commercial |
| 73 | 156.675 | 156.675 | Simplex | Port Operation |
| 74 | 156.725 | 156.725 | Simplex | Port Operation |
| 75 | 156.775 | 156.775 | Simplex, 1W | Port Operation |
| 76 | 156.825 | 156.825 | Simplex, 1W | Port Operation |
| 77 | 156.875 | 156.875 | Simplex, 1W | Port Operation |
| 78A | 156.925 | 156.925 | Simplex | Inter Ship |
| 79A | 156.975 | 156.975 | Simplex | Inter Ship |
| 80A | 157.025 | 157.025 | Simplex | Inter Ship |

| Canadian Marine Channels | | | | |
|---------------------------------|----------------|----------------|---------------|----------------------|
| Ch | RX Freq | TX Freq | Status | Name |
| 81A | 157.075 | 157.075 | Simplex | Canadian Coast Guard |
| 82A | 157.125 | 157.125 | Simplex | Canadian Coast Guard |
| 83 | 161.775 | 157.175 | Duplex | Canadian Coast Guard |
| 83A | 157.175 | 157.175 | Simplex | Canadian Coast Guard |
| 84 | 161.825 | 157.225 | Duplex | Marine Operator |
| 85 | 161.875 | 157.275 | Duplex | Marine Operator |
| 86 | 161.925 | 157.325 | Duplex | Marine Operator |
| 87 | 157.375 | 157.375 | Simplex | Port Operation |
| 88 | 157.425 | 157.425 | Simplex | Port Operation |

International channel frequencies and names

| International Marine Channels | | | | |
|--------------------------------------|----------------|----------------|---------------|---------------------------|
| Ch | RX Freq | TX Freq | Status | Name |
| 1 | 160.650 | 156.050 | Duplex | Marine operator |
| 2 | 160.700 | 156.100 | Duplex | Marine operator |
| 3 | 160.750 | 156.150 | Duplex | Marine operator |
| 4 | 160.800 | 156.200 | Duplex | Marine operator |
| 5 | 160.850 | 156.250 | Duplex | Marine operator |
| 6 | 156.300 | 156.300 | Simplex | Inter-ship safety |
| 7 | 160.950 | 156.350 | Duplex | Marine operator |
| 8 | 156.400 | 156.400 | Simplex | Commercial (ship-ship) |
| 9 | 156.450 | 156.450 | Simplex | Boater calling channel |
| 10 | 156.500 | 156.500 | Simplex | Commercial |
| 11 | 156.550 | 156.550 | Simplex | Vessel traffic system |
| 12 | 156.600 | 156.600 | Simplex | Vessel traffic system |
| 13 | 156.650 | 156.650 | Simplex | Bridge to bridge |
| 14 | 156.700 | 156.700 | Simplex | Vessel traffic system |
| 15 | 156.750 | 156.750 | Simplex, 1W | Environmental |
| 16 | 156.800 | 156.800 | Simplex | Distress, safety, calling |

| International Marine Channels | | | | |
|--------------------------------------|----------------|----------------|---------------|----------------------------|
| Ch | RX Freq | TX Freq | Status | Name |
| 17 | 156.850 | 156.850 | Simplex, 1W | Govt maritime control |
| 18 | 161.500 | 156.900 | Duplex | Port operation |
| 19 | 161.550 | 156.950 | Duplex | Commercial |
| 20 | 161.600 | 157.000 | Duplex | Port operation |
| 21 | 161.650 | 157.050 | Duplex | Port operation |
| 22 | 161.700 | 157.100 | Duplex | Port operation |
| 23 | 161.750 | 157.150 | Duplex | Marine operator |
| 24 | 161.800 | 157.200 | Duplex | Marine operator |
| 25 | 161.850 | 157.250 | Duplex | Marine operator |
| 26 | 161.900 | 157.300 | Duplex | Marine operator |
| 27 | 161.950 | 157.350 | Duplex | Marine operator |
| 28 | 162.000 | 157.400 | Duplex | Marine operator |
| 60 | 160.625 | 156.025 | Duplex | Marine operator |
| 61 | 160.675 | 156.075 | Duplex | Marine operator |
| 62 | 160.725 | 156.125 | Duplex | Marine operator |
| 63 | 160.775 | 156.175 | Duplex | Marine operator |
| 64 | 160.825 | 156.225 | Duplex | Marine operator |
| 65 | 160.875 | 156.275 | Duplex | Marine operator |
| 66 | 160.925 | 156.325 | Duplex | Marine operator |
| 67 | 156.375 | 156.375 | Simplex | Bridge to bridge |
| 68 | 156.425 | 156.425 | Simplex | Non commercial |
| 69 | 156.475 | 156.475 | Simplex | Non commercial |
| 70 | 156.525 | Inhibit | Receive only | Digital Selective Calling |
| 71 | 156.575 | 156.575 | Simplex | Non commercial |
| 72 | 156.625 | 156.625 | Simplex | Non commercial |
| 73 | 156.675 | 156.675 | Simplex | Port operation |
| 74 | 156.725 | 156.725 | Simplex | Port operation |
| 75 | 156.775 | 156.775 | Simplex, 1W | Port operation |
| 76 | 156.825 | 156.825 | Simplex, 1W | Port operation |
| 77 | 156.875 | 156.875 | Simplex | Port operation (ship-ship) |
| 78 | 161.525 | 156.925 | Duplex | Port operation |

| International Marine Channels | | | | |
|--------------------------------------|----------------|----------------|---------------|-----------------|
| Ch | RX Freq | TX Freq | Status | Name |
| 79 | 161.575 | 156.975 | Duplex | Port operation |
| 80 | 161.625 | 157.025 | Duplex | Port operation |
| 81 | 161.675 | 157.075 | Duplex | Port operation |
| 82 | 161.725 | 157.125 | Duplex | Port operation |
| 83 | 161.775 | 157.175 | Duplex | Port operation |
| 84 | 161.825 | 157.225 | Duplex | Marine operator |
| 85 | 161.875 | 157.275 | Duplex | Marine operator |
| 86 | 161.925 | 157.325 | Duplex | Marine operator |
| 87 | 157.375 | 157.375 | Simplex | Marine operator |
| 88 | 157.425 | 157.425 | Simplex | Marine operator |

Weather channel frequencies and names

| Channel | RX | Channel | RX |
|----------------|-----------|----------------|-----------|
| WX01 | 162.5500 | WX06 | 162.5000 |
| WX02 | 162.4000 | WX07 | 162.5250 |
| WX03 | 162.4750 | WX08 | 161.6500 |
| WX04 | 162.4250 | WX09 | 161.7750 |
| WX05 | 162.4500 | WX10 | 163.2750 |

FRS/GMRS Channels

| CH No. | RX Freq. (MHz) | TX Freq.(MHz) |
|--------|----------------|---------------|
| 1 | 462.5625 | 462.5625 |
| 2 | 462.5875 | 462.5875 |
| 3 | 462.6125 | 462.6125 |
| 4 | 462.6375 | 462.6375 |
| 5 | 462.6625 | 462.6625 |
| 6 | 462.6875 | 462.6875 |
| 7 | 462.7125 | 462.7125 |
| 8 | 467.5625 | 467.5625 |
| 9 | 467.5875 | 467.5875 |
| 10 | 467.6125 | 467.6125 |
| 11 | 467.6375 | 467.6375 |
| 12 | 467.6625 | 467.6625 |
| 13 | 467.6875 | 467.6875 |
| 14 | 467.7125 | 467.7125 |
| 15 | 462.5500 | 462.5500 |
| 16 | 462.5750 | 462.5750 |
| 17 | 462.6000 | 462.6000 |
| 18 | 462.6250 | 462.6250 |
| 19 | 462.6500 | 462.6500 |
| 20 | 462.6750 | 462.6750 |
| 21 | 462.7000 | 462.7000 |
| 22 | 462.7250 | 462.7250 |

CTCSS Code List

| Code No. | Freq. (Hz) | Code No. | Freq. (Hz) | Code No. | Freq. (Hz) |
|----------|------------|----------|------------|----------|------------|
| OFF | Off | 13 | 103.5 | 26 | 162.2 |
| 1 | 67.0 | 14 | 107.2 | 27 | 167.9 |
| 2 | 71.9 | 15 | 110.9 | 28 | 173.8 |
| 3 | 74.4 | 16 | 114.8 | 29 | 179.9 |
| 4 | 77.0 | 17 | 118.8 | 30 | 186.2 |
| 5 | 79.7 | 18 | 123.0 | 31 | 192.8 |
| 6 | 82.5 | 19 | 127.3 | 32 | 203.5 |
| 7 | 85.4 | 20 | 131.8 | 33 | 210.7 |
| 8 | 88.5 | 21 | 136.5 | 34 | 218.1 |
| 9 | 91.5 | 22 | 141.3 | 35 | 225.7 |
| 10 | 94.8 | 23 | 146.2 | 36 | 233.6 |
| 11 | 97.4 | 24 | 151.4 | 37 | 241.8 |
| 12 | 100.0 | 25 | 156.7 | 38 | 250.3 |

DCS Code List

| Code No. | DCS Code (Octal) | Code No. | DCS Code (Octal) | Code No. | DCS Code (Octal) |
|----------|------------------|----------|------------------|----------|------------------|
| 39 | 023 | 50 | 072 | 61 | 152 |
| 40 | 02 | 51 | 073 | 62 | 155 |
| 41 | 026 | 52 | 074 | 63 | 156 |
| 42 | 031 | 53 | 114 | 64 | 162 |
| 43 | 032 | 54 | 115 | 65 | 165 |
| 44 | 043 | 55 | 116 | 66 | 172 |
| 45 | 047 | 56 | 125 | 67 | 174 |
| 46 | 051 | 57 | 131 | 68 | 205 |
| 47 | 054 | 58 | 132 | 69 | 223 |
| 48 | 065 | 59 | 134 | 70 | 226 |
| 49 | 071 | 60 | 143 | 71 | 243 |

| Code No. | DCS Code (Octal) | Code No. | DCS Code (Octal) | Code No. | DCS Code (Octal) |
|-----------------|-------------------------|-----------------|-------------------------|-----------------|-------------------------|
| 72 | 244 | 96 | 464 | 120 | 743 |
| 73 | 245 | 97 | 465 | 121 | 754 |
| 74 | 251 | 98 | 466 | 122 | 36 |
| 75 | 261 | 99 | 503 | 123 | 53 |
| 76 | 263 | 100 | 506 | 124 | 122 |
| 77 | 265 | 101 | 516 | 125 | 145 |
| 78 | 271 | 102 | 632 | 126 | 212 |
| 79 | 306 | 103 | 546 | 127 | 225 |
| 80 | 311 | 104 | 565 | 128 | 246 |
| 81 | 315 | 105 | 606 | 129 | 252 |
| 82 | 331 | 106 | 612 | 130 | 255 |
| 83 | 343 | 107 | 624 | 131 | 266 |
| 84 | 346 | 108 | 627 | 132 | 274 |
| 85 | 351 | 109 | 631 | 133 | 325 |
| 86 | 364 | 110 | 632 | 134 | 332 |
| 87 | 365 | 111 | 654 | 135 | 356 |
| 88 | 371 | 112 | 662 | 136 | 446 |
| 89 | 411 | 113 | 664 | 137 | 452 |
| 90 | 412 | 114 | 703 | 138 | 454 |
| 91 | 413 | 115 | 712 | 139 | 455 |
| 92 | 423 | 116 | 723 | 140 | 462 |
| 93 | 431 | 117 | 731 | 141 | 523 |
| 94 | 432 | 118 | 732 | 142 | 526 |
| 95 | 445 | 119 | 734 | | |

Regulations and Safety Warnings

WARNING! Read this information
before using the radio.

Maritime Radio Services Operation

Warning! This transmitter will operate on channels/frequencies that have restricted use in the United States. The channel assignments include frequencies assigned for exclusive use of the U.S. Coast Guard, use in Canada, and use in international waters. Operation on these frequencies without proper authorization is strictly forbidden. See pages E-34 through E-31 for tables of the available channels and their uses. If you are still not certain which channels to use, see the FCC maritime radio page at the FCC website (<http://wireless.fcc.gov/marine/>) or contact the FCC Call Center at 1-888-CALL-FCC. For individuals requiring a license, such as commercial users, you should obtain a license application from your nearest FCC field office (for US users) or Industry Canada (for Canadian users).

Basic Radio Guidelines

You should familiarize yourself with the rules on marine radios and be aware of which rules apply to your boat. Complete guidelines for all ship and marine radio types can be found at the US Coast Guard website under the topic Radio Info for Boaters (the direct link is <http://www.navcen.uscg.gov/marcomms/boater.htm>). Here are a few guidelines that affect nearly all boaters.

- If you have a VHF radio on your boat, you must maintain a watch on channel 16 (156.800 MHz) whenever the radio is not being used to communicate. Starting in 2004, if a radio is carried, it must be on and set to channel 16 whenever your boat is underway.
- If you hear a distress call, wait a few minutes to let a shore station or Coast Guard vessel respond. If no other station has responded after 5 minutes, you must respond to the distress call.

- Do not make false mayday or distress calls as a prank or to test your radio. (This is essentially like making a false 9-1-1 call; you may be subject to fines.)

FCC/Industry Canada Information

- ◆ Certification: FCC Part 80 or RSS-182
- ◆ Output Power: 5W
- ◆ Emission: 16K0F3E
- ◆ Transmitter Frequency Range: 156.025-157.425 MHz

This device complies with Part 15 of the FCC Rules. Operation is subject to the following two conditions: (1) This device may not cause harmful interference. (2) This device must accept any interference received, including interference that may cause undesired operation.

Unauthorized changes or modifications to this equipment may void compliance with the FCC Rules. Any change or modification must be approved in writing by West Marine. Changes or modifications not approved by West Marine could void the user's authority to operate the equipment.

FCC RF Exposure Information

In August 1996 the Federal Communications Commission (FCC) of the United States with its action in Report and Order FCC 96-326 adopted an updated safety standard for human exposure to radio frequency electromagnetic energy emitted by FCC regulated transmitters. Those guidelines are consistent with the safety standard previously set by both U.S. and international standards bodies. The design of the radio complies with the FCC guidelines and these international standards.

Never allow children to operate the radio without adult supervision and the knowledge of the following guidelines.

WARNING! It is up to the user to properly operate this radio transmitter to insure safe operation. Please adhere to the following:

- Use only the supplied or an approved antenna. Unauthorized antennas, modifications, or attachments could impair call quality, damage the radio, or violate FCC regulations.

- Do not use the radio with a damaged antenna. If a damaged antenna comes into contact with the skin, a minor burn may result. Please contact your local dealer for a replacement antenna.

Hand-held Operation (Held-to-Face)

This device was evaluated for typical hand-held (held-to-face) operations with a 1 inch spacing from the front of the radio. For hand-held operation, the radio should be held 1 inch from the user's face in order to comply with FCC RF exposure requirements.

Body-Worn Operation

This device was tested for typical body-worn operations using the supplied belt-clip. To maintain compliance with FCC RF exposure requirements, body-worn operations are restricted to the supplied belt-clip. For hand-held operation, the radio should be held 1 inch from the user's face.

The use of accessories that do not satisfy these requirements may not comply with FCC RF exposure requirements and should be avoided. For more information about RF exposure, please visit the FCC website at www.fcc.gov.

Lithium ion battery warning

- ◆ This equipment contains a rechargeable Lithium Ion battery. The rechargeable battery contained in this equipment may explode if disposed of in a fire.
- ◆ Do not short-circuit the battery.
- ◆ Do not charge the rechargeable battery used in this equipment in any charger other than the one specified in the owner's manual. Using another charger may damage the battery or cause it to explode.
- ◆ Li-Ion batteries must be recycled or disposed of properly.
- ◆ Avoid exposing the battery (whether attached to the radio or not) to direct sunlight, heated cars, or temperatures below -4°F (-20°C) or above +140°F (+60°C). Exposing the chemical contained within the battery pack to temperatures above +140°F (+60°C) may cause the battery to rupture, fail, or reduce performance.

- ◆ In case of exposure to the cell contents, wash the affected area thoroughly, and seek medical attention.
- ◆ As part of our commitment to protecting our environment and conserving natural resources, West Marine voluntarily participates in an RBRC® industry program to collect and recycle used Li-Ion batteries within the United States. Please call 1-800-8-BATTERY for information on Li-Ion battery recycling in your area. (RBRC® is a registered trademark of the Rechargeable Battery Recycling Corporation.)



Three Year Limited Warranty Statement

This Limited Warranty is Void outside the United States of America and Canada.

What Does This Limited Warranty Cover?

West Marine warrants to the original retail purchaser of the West Marine product, where the purchase is made in the United States or Canada, that for thirty-six (36) months from date of original retail purchase said product will be free from defects in materials and craftsmanship with only the limitations or exclusions set out below.

How Long Does This Limited Warranty Last?

This limited warranty is valid for thirty-six (36) months from the date of the original retail purchase from West Marine within the United States (the "Limited Warranty Term").

The warranty period is not extended if we repair or replace a warranted product or any parts. West Marine reserves the right to change the availability of limited warranties, at its discretion, but any changes will not be retroactive and will only apply to subsequent purchases.

What Does This Limited Warranty Not Cover?

This limited warranty is invalid where and does not cover:

- ◆ Software.
- ◆ Commercial or industrial use or operation.
- ◆ Normal maintenance items or normal wear and tear.
- ◆ Problems resulting from fire or exposure to caustic liquids.
- ◆ The product was damaged, modified or altered.
- ◆ The product was used as part of any conversion kits, subassemblies, or any configurations not appropriate or contemplated for this product or its use.
- ◆ Damage or loss occurring during return shipment of the product to West Marine or its authorized service representative.
- ◆ The product was subject to improper service, repair, installation, storage, maintenance, alteration or application.
- ◆ Problems that result from accident, neglect, abuse, misuse or issues with electrical power,
- ◆ Problems caused by accessories, parts or components added to the product that are not appropriate for this product or its use.

THIS WARRANTY GIVES YOU SPECIFIC LEGAL RIGHTS, AND YOU MAY ALSO HAVE OTHER RIGHTS WHICH VARY FROM STATE TO STATE (OR JURISDICTION TO JURISDICTION). WEST MARINE'S RESPONSIBILITY FOR MALFUNCTIONS AND DEFECTS IN HARDWARE IS LIMITED TO REPAIR OR REPLACEMENT AS SET FORTH IN THIS WARRANTY STATEMENT. ALL EXPRESS AND IMPLIED WARRANTIES FOR THE PRODUCT, INCLUDING BUT NOT LIMITED TO ANY IMPLIED WARRANTIES AND CONDITIONS OF MERCHANTABILITY AND FITNESS FOR A PARTICULAR PURPOSE, ARE LIMITED IN TIME TO THE TERM OF THIS LIMITED WARRANTY (AS SPECIFIED ABOVE). NO WARRANTIES, WHETHER EXPRESS OR IMPLIED, WILL APPLY AFTER THE LIMITED WARRANTY PERIOD HAS EXPIRED. SOME STATES DO NOT ALLOW LIMITATIONS ON HOW LONG AN IMPLIED WARRANTY LASTS, SO THE ABOVE LIMITATIONS MAY NOT APPLY TO YOU.

WE DO NOT ACCEPT LIABILITY BEYOND THE REMEDIES PROVIDED FOR IN THIS LIMITED WARRANTY OR FOR

CONSEQUENTIAL OR INCIDENTAL DAMAGES, INCLUDING, WITHOUT LIMITATION, ANY LIABILITY FOR THIRD-PARTY CLAIMS AGAINST YOU FOR DAMAGES, FOR PRODUCTS NOT BEING AVAILABLE FOR USE, OR FOR LOST DATA OR LOST SOFTWARE. OUR LIABILITY WILL BE NO MORE THAN THE AMOUNT YOU PAID FOR THE PRODUCT THAT IS THE SUBJECT OF A CLAIM. THIS IS THE MAXIMUM AMOUNT FOR WHICH WE ARE RESPONSIBLE. SOME STATES DO NOT ALLOW THE EXCLUSION OR LIMITATION OF INCIDENTAL OR CONSEQUENTIAL DAMAGES, SO THE ABOVE LIMITATION OR EXCLUSION MAY NOT APPLY TO YOU.

What Must I Do To Keep the Warranty in Effect?

- ◆ You must keep your receipt or other appropriate documentation as proof of the date of sale and purchase.
- ◆ You must keep your serial number or order number for the product. This is found on the product itself or on your receipt.
- ◆ You must not do any of the things that will make the warranty invalid as provided for in this warranty statement.
- ◆ You must use, install, maintain and operate the product in accordance with published specifications and the user's manual.

What Do I Do If I Need Warranty Service?

- ◆ Before the warranty expires, please call us at 1-800-BOATING (1-800-262-8464). Please also have your West Marine serial number or order number available.
- ◆ When you contact us, we will issue a Return Material Authorization Number for you to include with your return. We will also provide you the address of where to ship the product.
- ◆ You must return the product to us in its original or equivalent packaging, prepay shipping charges, and insure the shipment or accept the risk if the product is lost or damaged in shipment.

What Will West Marine Do?

During the Limited Warranty Term, if the product you return to us proves to be defective in materials or workmanship and not for the reasons which would otherwise disqualify it (as explained here), then we will:

- ◆ At West Marine's option, we will repair the product or, if we are unable to repair it, we will replace it with a comparable product that is new or refurbished;
- ◆ Or, as an alternative, at West Marine's option, we will refund you the original purchase price;
- ◆ If we repair or replace the product, we will return the repaired or replacement product to you; and
- ◆ Pay to ship the repaired or replacement product to you if you use an address in the United States (excluding Puerto Rico and U.S. possessions and territories). Otherwise, we will ship the product to you freight collect.

If we determine that the problem is not covered under this warranty, we will notify you of this when we return your product to you to the address you provide us in the United States (excluding Puerto Rico and U.S. possessions and territories).

We use new and refurbished parts made by various manufacturers in performing warranty repairs and in building replacement parts and systems. Refurbished parts and systems are parts or systems that have been returned to West Marine, some of which were never used by a customer. Replacement parts and systems are covered for the remaining time left in the Limited Warranty Term for the product you bought (whatever time remains in the twelve months since purchase). West Marine owns all parts removed from repaired products.

Maintenance is the Owner's Responsibility

Cleaning, polishing, lubricating, replacing filters, tuning, replacing worn parts, using your purchased product according to the user's manual, and regularly maintaining your purchased product is your responsibility.

What if I purchased a Plus Protection Plan?

Service will be provided to you under the terms of the Plus Protection Plan Contract. Please refer to that contract for details on how to obtain service.

How State Law Relates to the Warranty.

This warranty gives you specific legal rights, and you may also have other rights which vary from state to state.