

# THE BEACH LT Assembly Guide

ORU KAYAK

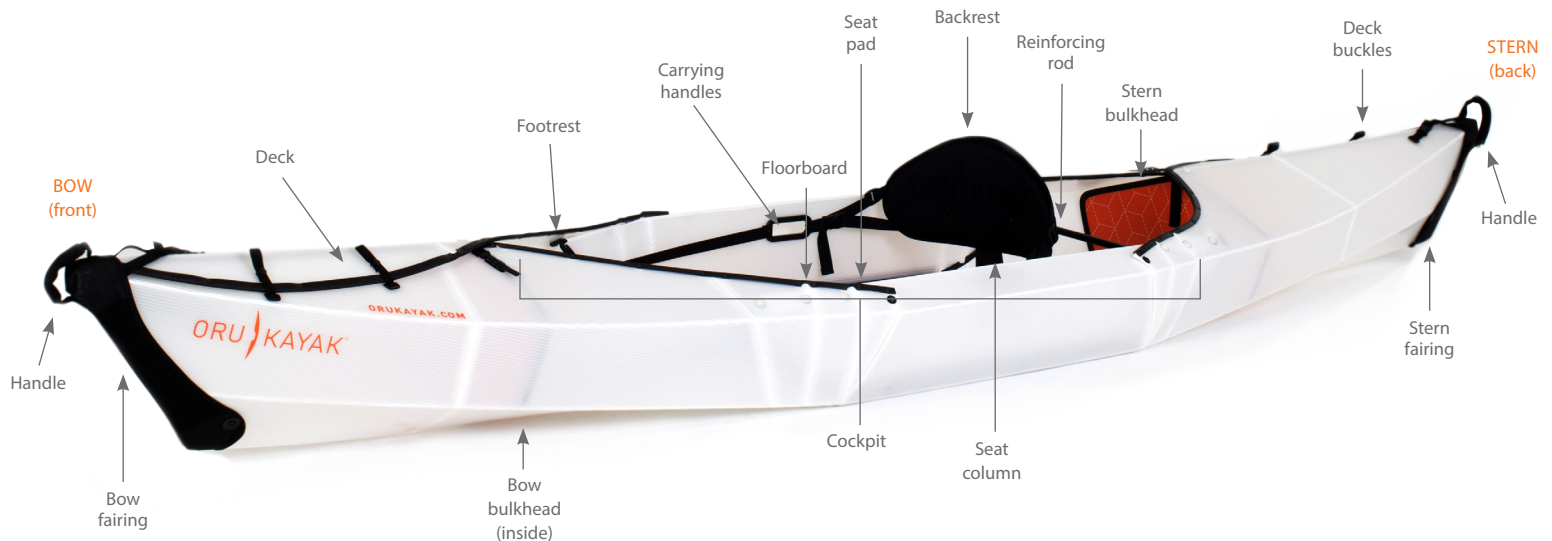

US PATENT NO. 8,316,788 OTHER PATENTS PENDING

WE'RE HERE TO HELP!

If you have questions, email us at [service@orukayak.com](mailto:service@orukayak.com)

## HOW TO GET STARTED

Read this entire Assembly Guide before assembling your Oru Kayak.

Watch the instruction video: [www.orukayak.com/pages/assembly](http://www.orukayak.com/pages/assembly)

Be patient! With practice your assembly time will get to 10 minutes or less.

# Step 1: Open the Oru Kayak box

The box contains all the components needed for assembly and includes space to store gear—such as our 4-piece paddle.

- A** Loosen and slide off the two loops that go around box. Set shoulder strap aside (you won't need it while kayaking).
- B** Lift the lid off. This will become the kayak's floorboard.
- C** Remove the loose kayak components packed into the box. See page 3 for a list of loose components. Additional components are permanently attached to the hull/deck.

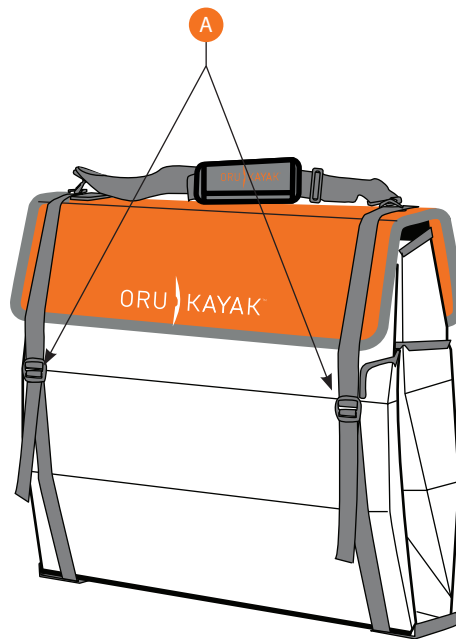

- B** The lid becomes the kayak's floorboard.

The box becomes the kayak's hull and deck.

# Parts: Loose components

- 1 **Shoulder strap:** Used to carry the kayak when in box form. Stow under back deck while kayaking.
- 2 **Floorboard:** Reinforces kayak bottom and holds the seat.
- 3 **Stern (back) bulkhead:** Provides structural rigidity.
- 4 **Backrest:** Includes the seat column and adjustable backrest. An attached rod reinforces the cockpit, and provides structural rigidity.
- 5 **Seat pad:** Tucks under the bungee in the floorboard.
- 6 **Spare parts kit:** Extra hardware for repairs and upkeep.

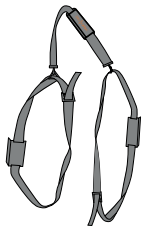

1

SHOULDER STRAP

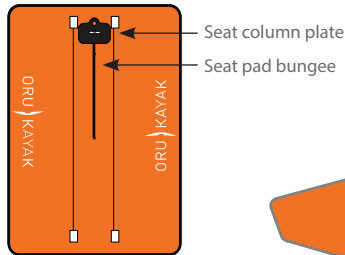

2

FLOORBOARD



3

STERN (BACK) BULKHEAD

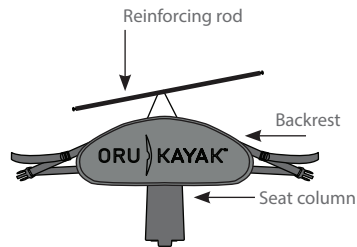

4

BACKREST

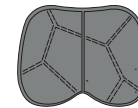

5

SEAT PAD

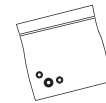

6

SPARE PARTS KIT

## Step 2: Unfold the box

- A** Unclip side straps that are keeping the kayak closed.
- B** Hold the two folds at the orange stickers. Pull as indicated in the illustration to open. The skin will be stiff.
- C** Push the ends apart to extend the box into a long sheet.
- D** Pop the hull flat with your hands as you extend it, pushing down the inverted folds, creating a bowl shape.

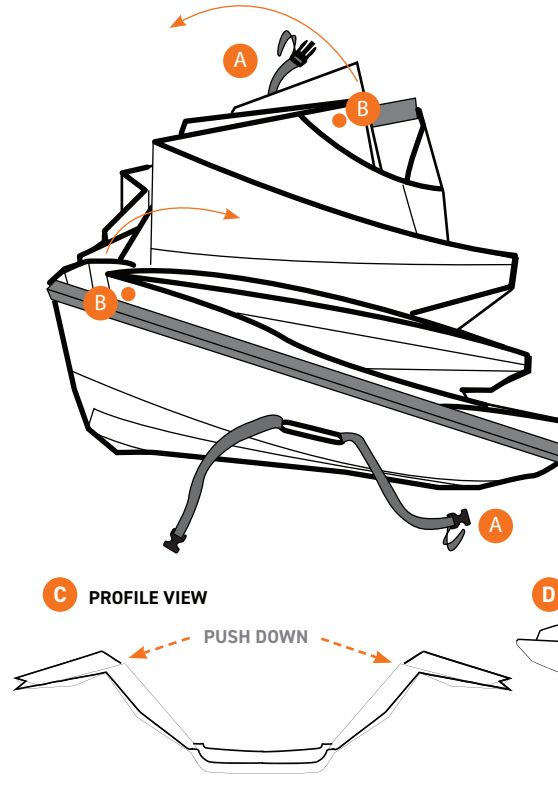

### NOTE

The double-walled corrugated polypropylene that Oru Kayaks are made from will naturally show marks and scratches from use over time. As long as the hull is not punctured, there is nothing to worry about. Think of them like marks and scratches on thick leather boots.

### TIP

For help on this step, reference the assembly video at [www.orukayak.com/pages/assembly](http://www.orukayak.com/pages/assembly)

# Parts: Hull/deck

The box becomes the hull and deck of the kayak. Several key parts are permanently attached to the hull/deck. The bow (front) and stern (back) of the Oru Kayak are different, so pay attention to orientation throughout the assembly process.

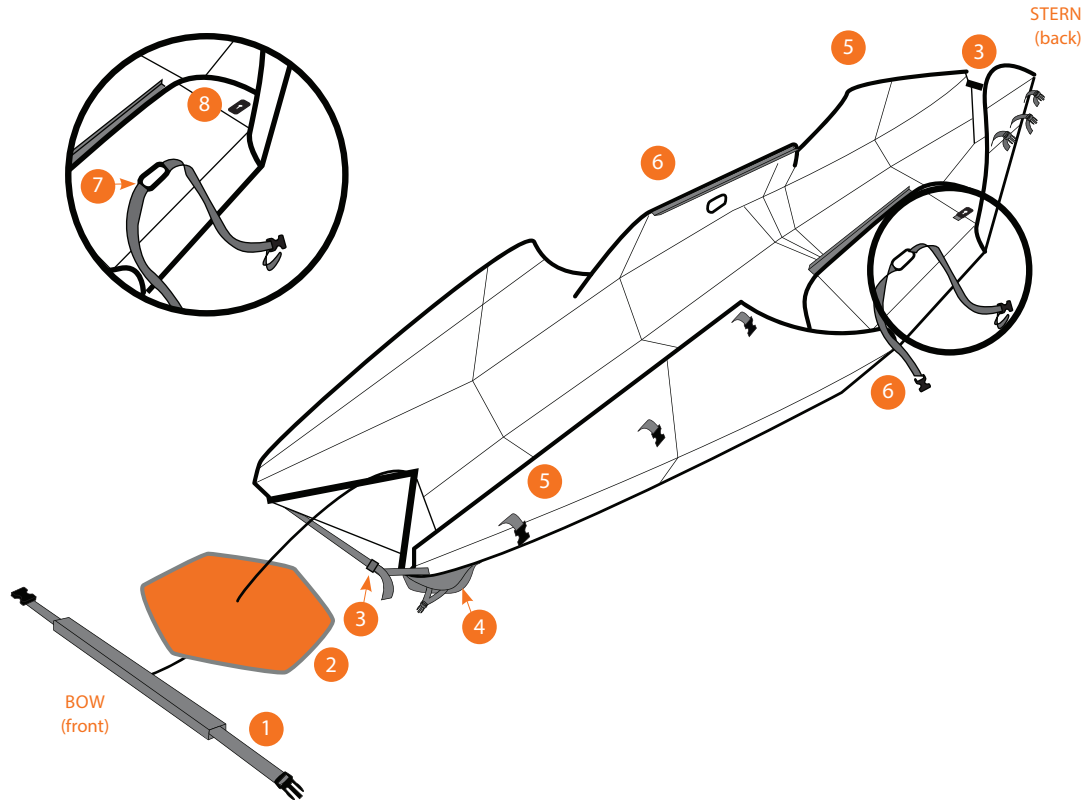

- 1 Footrest: For stability and to keep your legs comfortable.
- 2 Bulkheads: Provide structural rigidity.
- 3 End straps: Help keep the bow and stern tightly closed.
- 4 Fairings: These finish the boat at the bow and stern and include handles for carrying the kayak.
- 5 Deck buckles: Close the deck and hold the kayak together.
- 6 Adjustable footrest straps: Clip to the footrest to keep it in place. In box form, these serve as box closure straps.
- 7 Carrying handles: Make the kayak easy to pick up and carry.
- 8 Keyholes: Rod on seat back attaches here to reinforce cockpit.

## Step 3: Attach the footrest

- A** Fold in flaps on sides of cockpit.
- B** Pull footrest and bulkhead into hull.
- C** Clip footrest to adjustable footrest straps as shown.

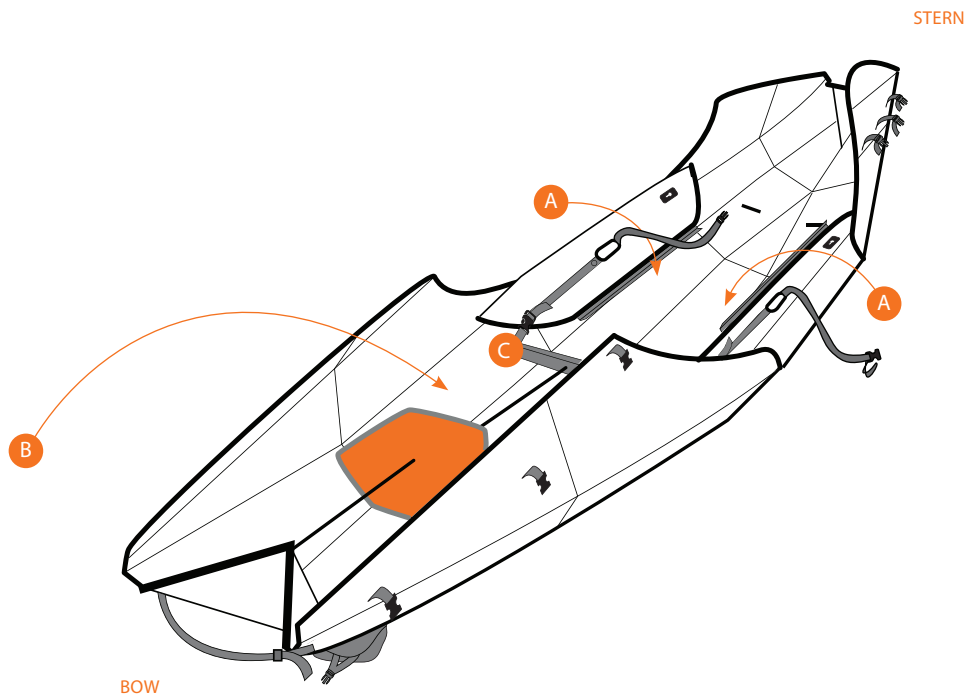
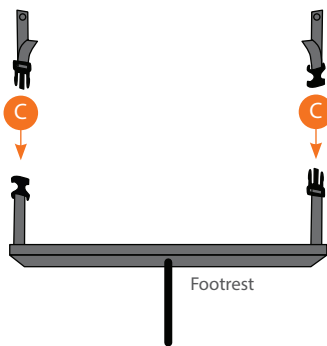

## Step 4: Close the front of the kayak

- A** 1 Make sure the ends are inverted.
- 2 Fully tighten the end strap at bow. See note.
- B** Place attached bow bulkhead in bulkhead channels and forward towards cockpit of screw. You may have to hold it there while starting the next step.
- C** Place flap with curved edge over flap with straight edge, as shown. Engage the cockpit side release buckle. Tighten by pulling the strap.
- D** Buckle the other two straps. Tighten by pulling the strap.
- E** Attach velcro to top of bulkhead, as shown in close-up.
- F** Stretch front fairing over bow, and clip small buckle onto deck buckle.

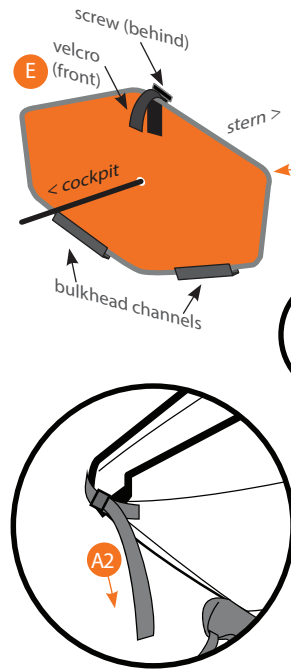

**CLOSE-UP**  
Fully tighten end strap at bow by pulling on strap and squeezing bow together.

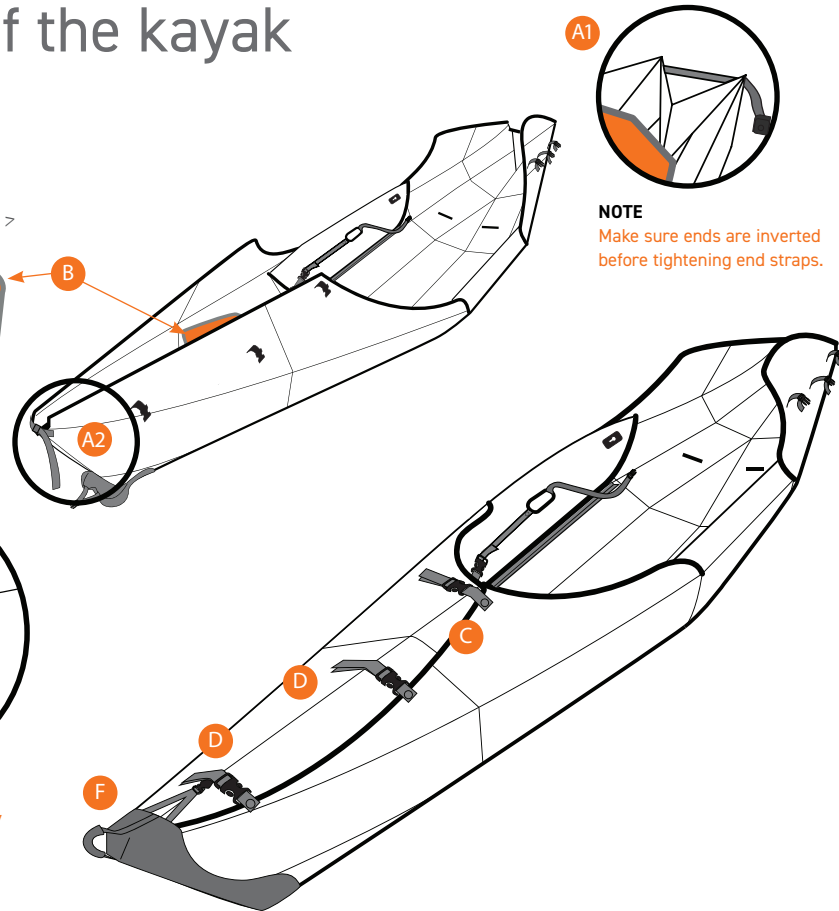

### NOTE

Make sure ends are inverted before tightening end straps.

## Step 5: Close the back of the kayak

Closing the back of the kayak is similar to closing the front (Step 4).

### NOTE

If the fairings won't stretch over, make sure the ends are inverted (see 4A).

- A** Fully tighten the stern (back) end strap.
- B** Place loose stern bulkhead in bulkhead channels as shown (make sure the side with velcro is on top). You may have to hold it there while starting the next step.
- C** Place flap with curved edge over flap with straight edge, as shown. Start with cockpit buckle then move to other two buckles, loosely closing each one. Do not tighten until end of Step 7.
- D** Attach velcro to top of bulkhead as shown, like in Step 4.
- E** Stretch rear fairing over stern, and clip small buckle onto last deck strap and tighten.
- F** Tighten stern straps.

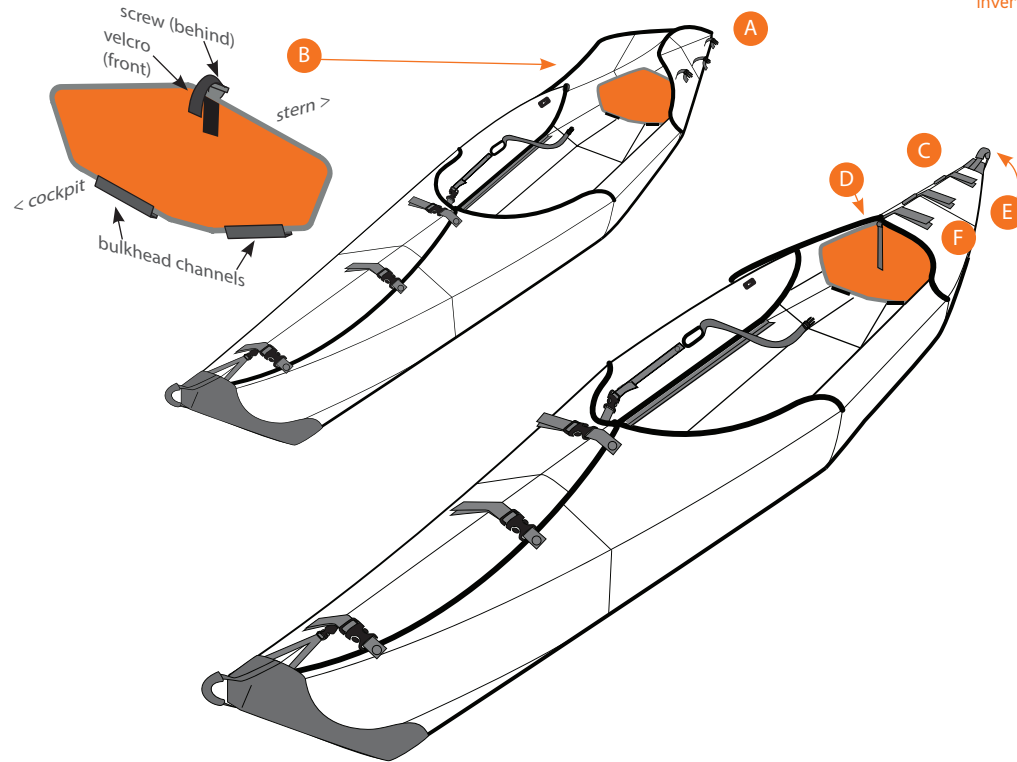



## Step 6: Insert the floorboard

on't  
ke  
e  
).

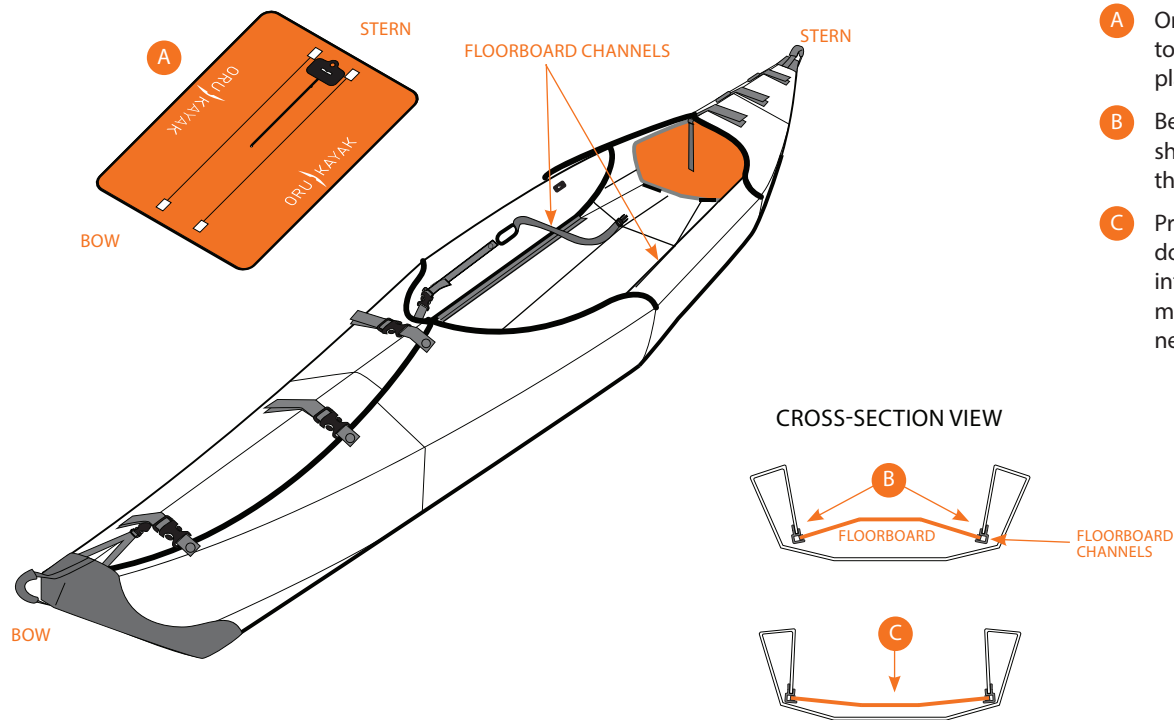

- A** Orient floorboard relative to hull as shown (seat back plate towards stern).
- B** Bend floorboard upward as shown below. Place edges of the floorboard into channels.
- C** Press center of floorboard down and push floorboard into channels (floorboard may not sit flat until the next step).

## Step 7: Install the seat

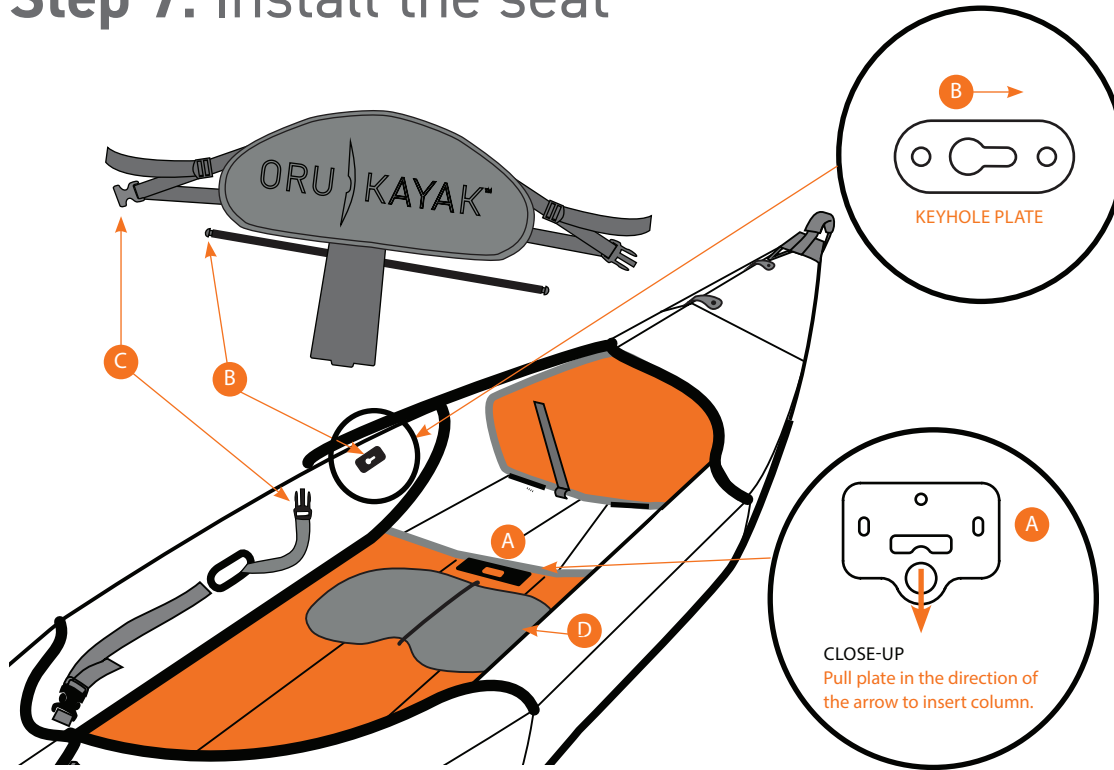

- A** Insert the bottom of seat column into slot of seat column plate on floorboard.
- B** Install reinforcing rod into keyholes on sides of cockpit: insert tube head on each end of rod into keyhole and gently tap rod backward to lock into place.
- C** Clip seat back straps into buckles on carrying handles.
- D** Place seat pad under bungee on floorboard.

# Final adjustments

## BEFORE YOU GET IN:

### LOOSEN THE FOOTREST STRAPS

This will allow easy entry.

### ADJUST THE BACKREST

- A** Loosen the knob on the rear of the seat one full turn. (over-turning may cause the knob to fall off.)
- B** Slide the seat oval to the desired height.
- C** Re-tighten the knob until the seatback is secure.

## ONCE YOU'RE IN:

### ADJUST THE BACKREST TENSION

- D** Tighten, or loosen the seatback straps, while leaning against the backrest.
- E** The footrest should keep your legs comfortably bent, with your knees played outward. To adjust its distance from you, tighten or loosen adjustable straps.

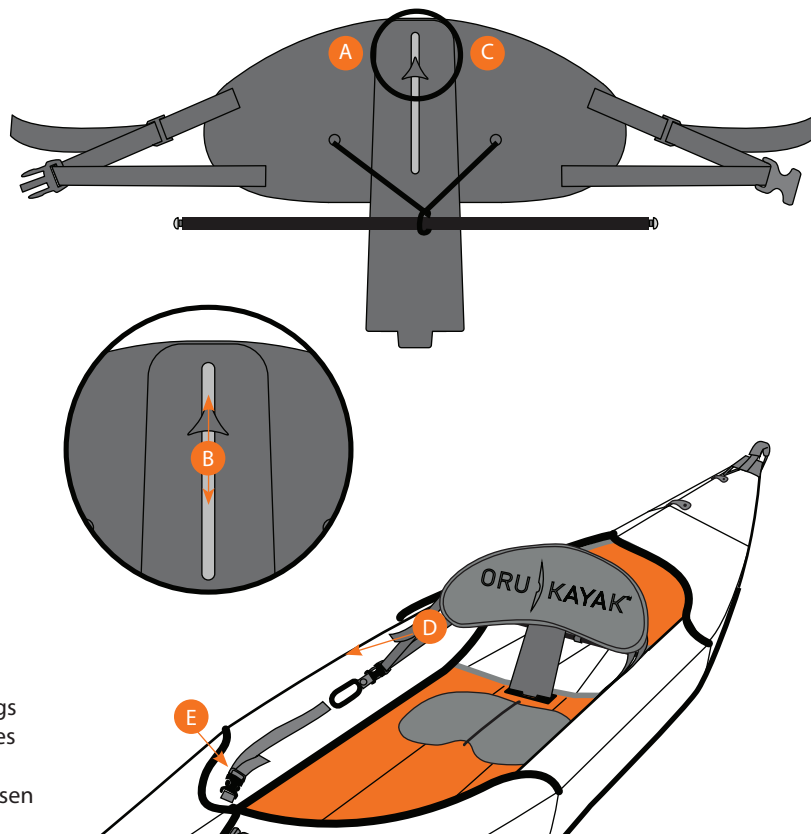

## ASSEMBLY CHECKLIST

- Bow and stern bulkheads are in bulkhead channels.
- Both ends of reinforcing rod are locked into keyholes behind seat.
- All footrest and seat buckles are clipped and tightened.
- All deck buckles are secure.
- Bow and stern straps are tight and the fairings cover both ends.

Congratulations!  
Your Oru Kayak is ready  
for the water.

# Back on land: Folding your Oru Kayak into its box

Disassembling the Oru Kayak is basically a reversal of the assembly, however there are a few tricks.

**Follow these simple directions to learn how to pack your Oru Kayak back into its box quickly and easily.**

- 1 Moving from bow to stern, unbuckle and loosen every side-release buckle of the deck.
- 2 Pull off both fairings and fully loosen both end straps.
- 3 Pull footrest and bow bulkhead out of hull and lay on ground. Remove seat pad and loose stern bulkhead.
- 4 Remove seatback: unbuckle seat back buckles, take reinforcing rod out of keyholes, release tension by pulling back on the floorboard plate, and pull seatback out.
- 5 Lift up on floorboard to remove. If rubber trim sticks in channels, try wiggling it.
- 6 Fold either bow or stern inward like an accordion. Using your knee helps!
- 7 Repeat with other end.
- 8 Push the orange arrow towards the orange target, and the black arrow towards the black target until box is formed.
- 9 Place footrest and bulkhead into folded boat, followed by other loose components, such as the seat back.
- 10 Bring male strap from one handle to the side of the box, and clip into the female buckle. Tighten. Repeat on other side.
- 11 Stash loose components throughout the box, making sure that they're safely positioned.
- 12 Place the floorboard over the top of the box, seat column plate facing up. Place and tighten the shoulder strap loops over the box.
- 13 All packed up and ready to go!

**TIP:** Some water may collect inside the plastic corrugated flutes. To let it drain, stand the assembled kayak vertically for about 10 minutes.

The shoulder strap makes it easy to carry the Oru Kayak short distances; for longer trips we recommend our Oru Pack. Available at [www.orukayak.com/products/oru-pack](http://www.orukayak.com/products/oru-pack)

**FOR STEP-BY-STEP VIDEO INSTRUCTION**

**WATCH THE ASSEMBLY VIDEO:**

[www.orukayak.com/pages/assembly](http://www.orukayak.com/pages/assembly)