



Marine Grade 400 Watt Wind Turbine



Serial number : _____

Please read and understand this manual completely before operating the machine.

INTRODUCTION:

- ★ This manual contains installation and safety information for the **Nature Power Marine Grade 400 Watt Wind Turbine**. The information in this manual is believed to be accurate and reliable; however, The Distributor assumes no responsibility for inaccuracies or omissions. Nature Power reserves the right to make changes to this product specification, or its manual, without prior notice. Therefore, check the Nature Power Website for updates as necessary.
- ★ The **Nature Power Marine Grade 400 Watt Wind Turbine**, like other sources of electrical power, must be installed following the guidelines established by state and local regulations. Consult a local electrician or local planning and zoning offices for detailed information about your area.
- ★ For your ease write the serial number of your **Nature Power Marine Grade 400 Watt Wind Turbine** on the front of this manual. Store your manual and receipt together. You will need this information in the event of a warranty claim.

CONGRATULATIONS!

You will find your new wind turbine easy to install. However, it is important that you read this manual thoroughly prior to installation to assure proper performance and safety.

If you have any questions after reading the manual, please contact the Distributor.

TABLE OF CONTENTS

1. PRECAUTIONS	4
1.1 Mechanical Hazards	4
1.2 Electrical Hazards	4
1.3 Installation Precautions	4
1.4 Operation Precautions	4
2. PACKAGE CONTENTS	5
3. WIRING AND INSTALLATION PROCEDURES	6
3.1 System wiring diagrams	6
4.LOCATION SELECTION	7
5. TOWER	8
6.1 SINGLE WIND GENERATOR	9
6.2CONTROLLER WIRING	10
6.3 INSTALLATION OPERATION	11
6.4 ATTACHING TO POLE	11
6.5 STEP-BY-STEP INSTRUCTION	12
7. WARRANTY POLICY	15
7.1 ELEVATION	15
8. SPECIFICATIONS	16

1. PRECAUTIONS

The **Nature Power Wind Turbine** has been designed with your safety in mind. However, there are inherent dangers involved with any electrical and/or mechanical equipment. **Safety must be your primary concern as you plan the location, installation and operation of the turbine. At all times be aware of electrical, mechanical and rotor blade hazards.**

1.1 MECHANICAL HAZARD

Rotating blades present the most serious hazard. The rotor blades are made of very strong thermoplastic. At the tip, the blades may be moving at velocities over 275 miles per hour (440 km/hr). At this speed, the tip of a blade is nearly invisible and can cause serious injury. Under no circumstances should you install the turbine where a person could come in contact with moving rotor blades. **DO NOT INSTALL THE TURBINE WHERE ANYONE CAN APPROACH THE PATH OF THE BLADES.**

1.2 ELECTRICAL HAZARDS

*Observe all manufacturers' safety procedures when working around batteries and other electrical equipment.

The **Nature Power Wind Turbine** is equipped with sophisticated electronics designed to provide protection from high surge electrical dangers. The external controller of the **Nature Power Wind Turbine** prevents open circuit voltages from rising above 20 volts for 12-volt systems. Please note that the inherent personal dangers from electrical current still exist, therefore caution should always be used when connecting this and other electrical devices.

Heat in wiring systems is often a result of too much current flowing through an undersized wire or through a bad connection.

Batteries can deliver a dangerous amount of current. If a short occurs in the wiring from the batteries, a fire can result. In order to avoid this threat, a properly sized fuse or circuit breaker is required in the lines connecting to the battery.

1.3 INSTALLATION PRECAUTIONS:

Installation procedures should be performed at ground level.

Make sure that all batteries are disconnected throughout the installation process. Never install the **Nature Power Wind Turbine** upside down. Choose a day when the wind is calm.

Connect the 3 wires coming from the Wind Turbine to the AC Input terminal on the Charge Controller in any order. Connect additional wires to the DC Output terminals on the Charge Controller (Black = Negative (-) Red = positive (+)) ensuring they do not come into contact with each other

1.4 OPERATION PRECAUTIONS

Never approach the turbine during operation.

Check support structures, blades, and electrical systems regularly. The rotor blades are very strong; however, if they come in contact with a solid object, they can break. When performing periodic inspections, or if you must approach the path of the blades, disconnect the power leads from the battery and tie the wind turbine output leads together to stop /slow down the blades from rotating.

Note: There is a short break-in period with new wind turbines. The bearings in both the turbine yaw and the turbine rotor will require approximately 60-100 hours of operation in normal wind speeds (approximately 18 – 20 mph, 8 – 9 m/s) before they are running at peak efficiency. During this break-in period, the turbine operation might appear sluggish.

2. PACKAGE CONTENTS

USE CHART BELOW TO COMPARE PARTS.

ROTOR BLADES ARE SHARP. PLEASE HANDLE WITH CARE.

- | | |
|-------------------------------------|-------------------------------|
| 1. Nose Cone | 9. Stator |
| 2. Screw Socket Head x6 | 10. Rotor |
| 3. Nut-Jam- SAE 5/8-18 | 11. O-Ring |
| 4. Blade x3 | 12. Body Assembly |
| 5. HUB | 13. Snap Ring- 32 MM External |
| 6. Nut-Nylock- SAE 6-32 x3 | 14. Yaw Shaft Assembly |
| 7. Screw Socket head 10-24x1-1/2"x3 | 15. Wind Generator controller |
| 8. Face Assembly | |

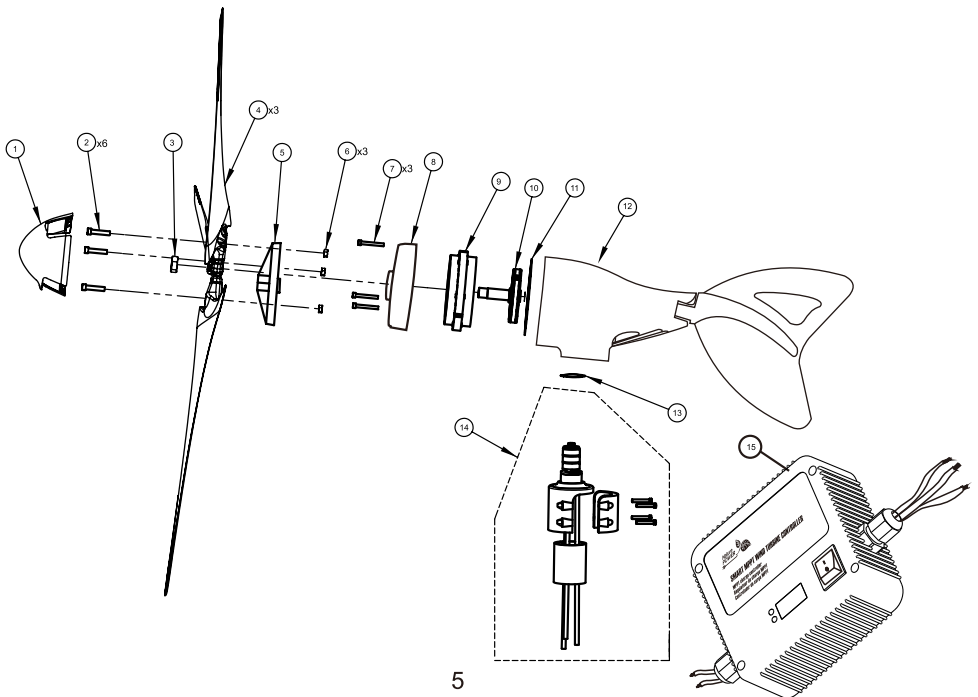

3. WIRING AND INSTALLATION PROCEDURES

Your **Nature Power Wind Turbine** is shipped partially assembled. Please completely read all procedures before beginning installation.

NOTE: Do not install the blade/hub until the turbine is mounted on the tower.

Necessary Tools:

4mm hex key wrench (included)

5mm hex key wrench (included)

8mm hex key wrench (included)

Power cables (not included):

#12 AWG (American Wire Gage) stranded.

Batteries (not included)

Steel Pipe: 1 1/2", Schedule 40 steel pipe (Actual OD 1.875 inches, 48mm) (not included)

Torque wrench with 4mm, 5mm, and 8mm hex drives (not included)

Soldering iron or propane torch (not included)

Rosin core solder (not included)

Electrical tape or 1/4" (6-7mm) heat shrink (not included)

Wire strippers (not included)

Wire crimpers (not included)

3.1 SYSTEM WIRING DIAGRAMS

Precheck

NOTE: Do not connect to the battery.

Spin rotor shaft slowly with your fingers while at the same time connecting and disconnecting the DC OUTPUT's positive and negative wires. With the wires connected, the rotor shaft should become more difficult to rotate. With the wires disconnected, it should spin freely.

Every time connect the DC OUTPUT's wires (RED= Positive, BLACK = Negative) directly to the set of posts of the battery, the controller LED will lighten to indicate that the controller is running properly.

CAUTION: DO NOT CONNECT WIND GENERATOR POSITIVE TO BATTERY NEGATIVE AND CHARGE CONTROLLER NEGATIVE TO BATTERY POSITIVE FOR EVEN A SECOND, OR ELSE WILL DAMAGE THE WIND GENERATOR'S CONTROLLER AND VOID YOUR WARRANTY.

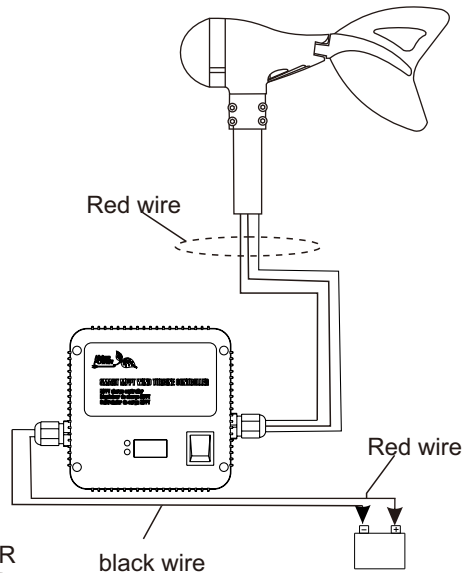

4. LOCATION SELECTION

To ensure good performance from the Wind Generator, it is important that care is taken in the site of the machine. Buildings, trees and rocky outcrops etc. disrupt the smooth flow of wind creating a "Wind Shear" with the wind velocity nearer the ground being slower than that higher up. Turbulence is also created by these obstructions. Turbulence is detrimental as the swirling air causes the Wind Generator to yaw continually thus stressing the mechanical parts and greatly increasing wear and tear.

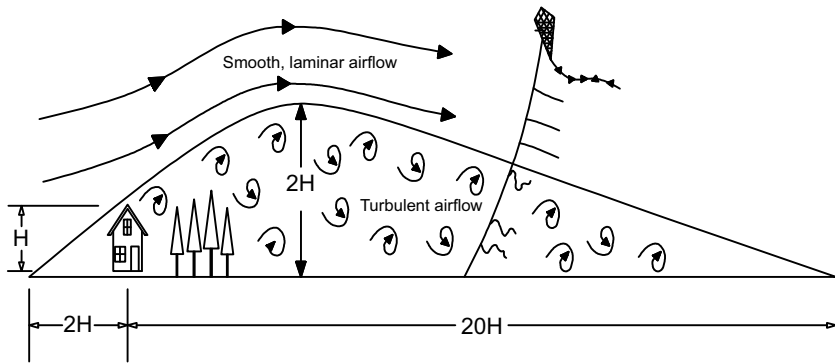
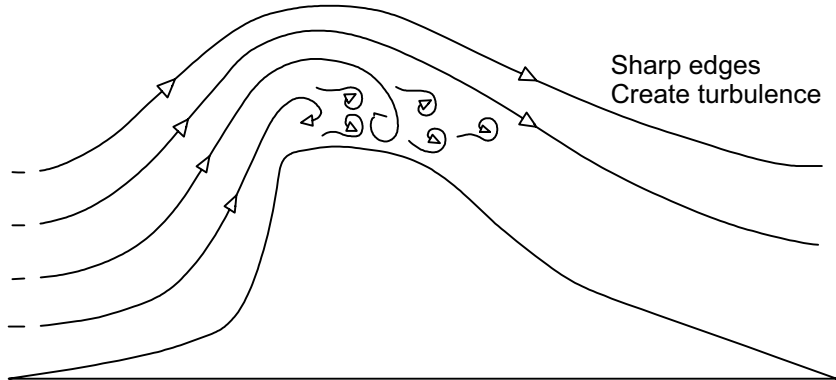

Turbulent airflow created by obstructions (Ad. P. Gipe, 93)

Therefore, as a general rule the Wind Generator should be mounted twice as high as any such obstructions. The power obtained from the wind is proportional to the cube of the wind speed, and the wind speed increases with height from the ground. A 26% increase in wind speed from a higher tower will yield a 100% increase in power from the wind generator. A little more money spent on a higher tower will harvest the same power as 2 machines! Preference should be given to the prevailing wind direction, but it should be noted that tall features behind the Wind Generator can also slow down the wind flow through the Wind Generator.

The Wind Generator should be mounted on a tower a minimum of 25' (8 meters) above any surrounding objects within a 500' (150m) radius. If this is not possible, then place it as high as you can. If this is a roof top installation, it is important there are no objects around the structure that may block the wind.

5. TOWER

Great care should be taken in the selection and preparation of the wind generator's tower, as this is the most difficult and crucial aspect of the entire installation. If you select a tower from another source or build your own, you are responsible for assuring the tower is suitable. As with all towers, you must first evaluate your site to determine the appropriate tower height, available space and reasonable cost.

The following list considerations must be consulted:

- Number of Wind Generators
- Budget
- Type: guyed, freestanding or rooftop
- Site: hills, trees, buildings
- Ease of use

Note: Guyed And Freestanding Towers Are The Most Common Way To Install A Wind Generator. These Towers Are Available In All Shapes, Sizes And Costs.

Caution: Do Not Install The Wind Generator Where The Path Of The Blades Can Be Reached During Normal Operation! Never Approach The Wind Generator During Operation!

Usually, the higher tower is erected, the greater the output, but also the greater cost and effort of the installation. If purchasing a taller tower will provide significantly more power it might offset the additional cost and effort. It's very important to mount the wind generator in the best winds while being balanced by the cost and effort of the installation.

This Wind Generator is designed to use steel pipe 1.875 inch (48mm) outside diameter, equivalent to 1 ½ inch SCH 40 pipe, which can be used in some tower applications. If larger pipe is used for your tower, make sure that the 1.875 inch pipe is at least 22 inch long or will damage the blades. **Refer to SPHERE OF OPERATION (Minimum Safe Pole Length Above Obstructions).**

CAUTION: SAFETY, ENGINEERING AND LOCAL CODES MUST BE ADDRESSED BEFORE ATTEMPTING ANY INSTALLATION.

NOTE: The yaw wires can support loads up to a total of 155 lbs. (70kg). If the wire weight is higher, you must install a strain relief to minimize the stress put on the hanging wires.

NOTE: Towers must be capable of withstanding 155 lb. (70kg) of load in the horizontal direction at the Wind Generator.

6.1. Single wind generator

See Diagram below for further wiring information

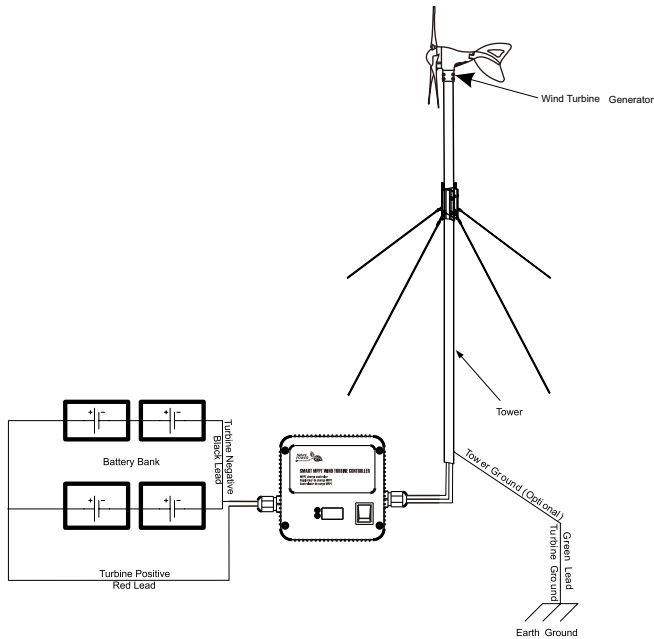

The controller Indicator Lamp

Mode	Lamp	LED reading	Status	Cause	Operation
Normal mode	No light	0. 0.	not reach charging wind speed	Rotor not reaching 500rpm charging speed	Normally
Normal mode	Solid Green	Current power	Charging wind speed to 12m/s	Rotor rotating at 500-1400rpm	Normally
Normal mode	Flashing red	0. 0.	Rotor rotating at low spin or stop	Battery fully charged (voltage exceeds 14.2V) or 24V system 26. 2V	Normally
Normal mode	Solid red	0. 0.	Rotor rotating at low spin or stop	Over speed, Rotor rotating over 1400rpm	Waiting 15mins, then restart the system
Stop mode	Solid red	No display	Rotor rotating at low spin or stop	Battery voltage exceeds 17.5V or 24V system exceeds 28.6V	System returns to normal mode if the battery voltage drops below 13.2V 24Vsystem 24.2V
		0. 0.		Controller temperature exceeded 85°C	System returns to normal mode if controller temperature drops below 60°C
Stop mode	Flashing red about 2sec	No display	rotation and stop suddenly	No Battery or cable loose	Connect with battery the system come to normal

6.2 CONTROLLER WIRING

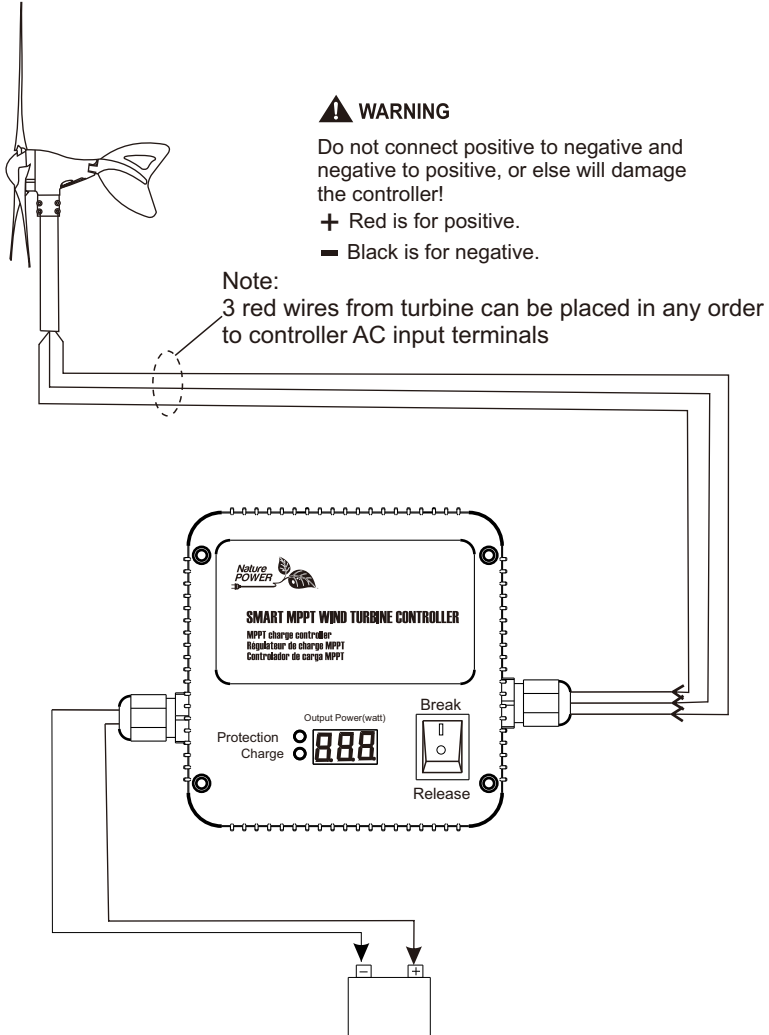

Note:
When green light is on, the wind turbine is in charging; red light is on, the wind turbine is in protection mode. Digital screen shows out the output power every one second.

For more information about some very economical tower kits for the wind generator, please refer or purchase them from your dealer or distributor.

6.3 INSTALLATION OPERATION

Choose a calm day and have someone available to help during the installation process.

NOTE: THE BLADE EDGES ARE SHARP. PLEASE HANDLE IT CAREFULLY.

NOTE: DO NOT install the blade assembly until the body is mounted on the tower.

CAUTION: ALL BATTERIES MUST DISCONNECTED THROUGHOUT THE INSTALLATION PROCESS!

CAUTION: DO NOT INSTALL THE WIND GENERATOR WHERE THE PATH OF THE BLADES CAN BE REACHED DURING NORMAL OPERATION! NEVER APPROACH THE WIND GENERATOR DURING OPERATION!

USE COMMON SENSE AND PLEASE BE CAREFUL!

6.4 Attaching to pole

While attaching the wind turbine to the tower, be careful not to pinch the yaw wires. Slide the yaw all the way down over the end of pole. After the yaw is seated on the pole, move it back up a 1/8th inch (2mm) to prevent the bottom of the yaw from contacting the top of the pole. This way the only contact between the tower and yaw is through the rubber pad, which will reduce noise transmission. Tighten all mounting fasteners to 3-5 foot pounds. (4. 1-6.8 N.m.). Make sure that your tower allows for proper clearance of the blades. A minimum of 2 inches (20mm) clearance must be given between the blade tips and any obstructions.

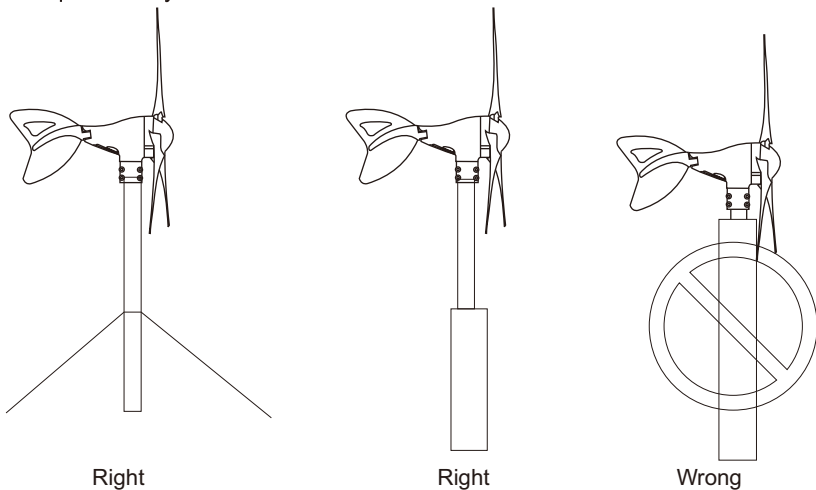
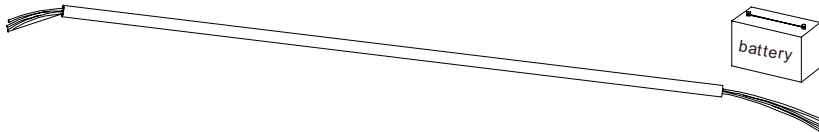

Figure 3 Proper Blade-to-Tower Clearances

6.5 Step-by-step instructions

The following step by step installation procedures provide you with an outline of the **Nature Power Marine Grade 400 Watt Wind Turbine** installation process. This consolidated reference should only be used as an outline during installation. Refer to the appropriate sections for further details.

- 1). Ensure the voltage systems of the wind generator and the battery bank are the same. Prepare the appropriate wires.
- 2). Run the wire through the pipe and drag the wires near to the batteries (Do not connect to the battery), strip the insulation back from each set of wires.



- 3). Connect the Wind Generator to the wires and insulate the connections using either heat shrink tubing or a quality electrical tape.

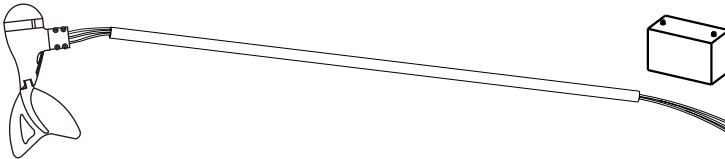

- 4). Once the yaw shaft is on the tower, firmly tighten the yaw clamp screws with the 4mm hex key to 3-5 foot pounds (4.0-6.5Nm). Be sure that it is securely attached to the mounts.

Slide the yaw shaft all the way down over the end of pole being careful not to pinch the yaw wires. Be sure to leave enough slack in the wires so that if necessary, the Wind Generator can be removed.

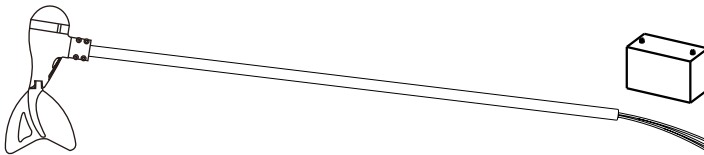

- 5) Prepare a grounding cable from yaw shaft screw, secure the grounding cable against the pipe with insulation tape for grounding the wind generator by the pipe.

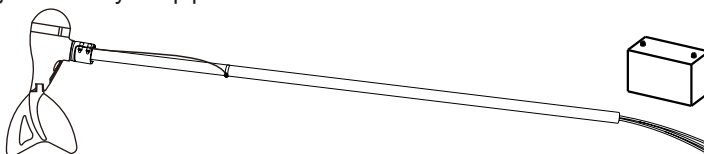

6).Place one of the blades on the hub socket and insert one of the M6-16 socket head cap screws. Place a plastic disk on the end of the screw, then place self-locking nut (M6) and tighten it with the 5mm hex key to 8-10 foot lbs. (10.5-13.5 N.m). Repeat this procedure on all three blades.

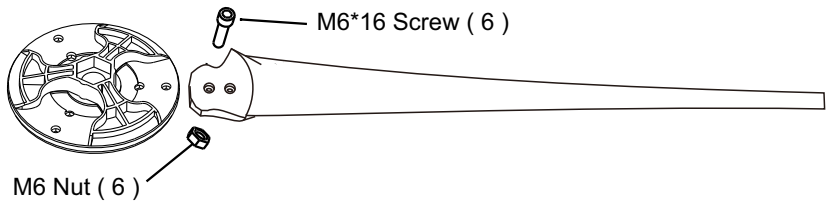

7). Remove the M16 nut from the rotor shaft. Slide the blades assembly onto the rotor shaft and place the nut on the shaft. DO NOT press the rotor shaft into the body.

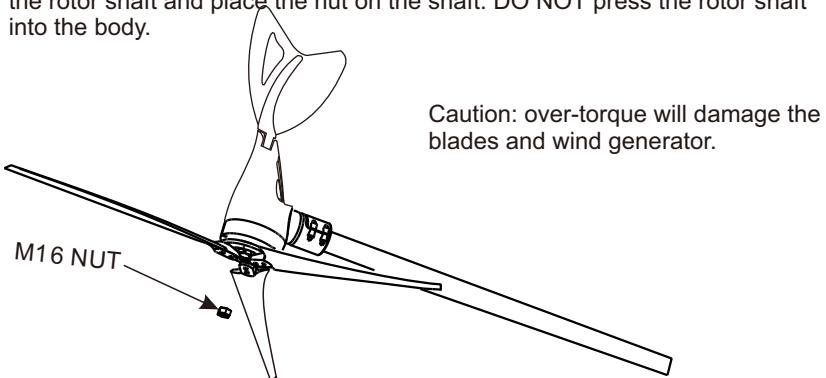

8).Insert the 8mm hex key into the rotor shaft and thread the nut on by spinning the blades assembly. Holding the blades assembly and tightening the M16 nut lightly with the 8mm hex key. Finally, spin the blades slowly to be sure they turn freely.

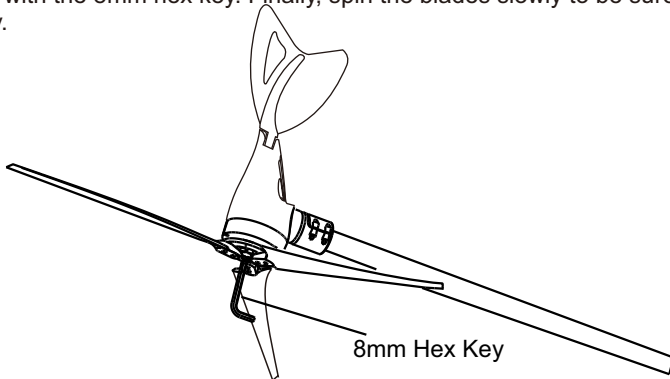

CAUTION: DO NOT SCREW M16 NUT TOO TIGHTLY, OTHERWISE THE FACE BEARING WILL BE STUCK AND THE BLADES ROTATE DIFFICULTLY!

9) Place the nose cone over the center line of the blades assembly and snap the nose cone into place. Carefully check it is secure by firmly pulling on and be sure all three edges are catch. Don't worry if the nose cone missing, it will not affect the performance of the wind generator.

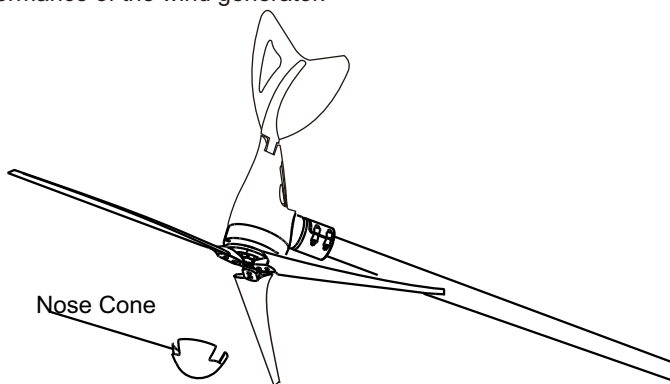

9) **Before attaching the wiring to the battery, make sure that:**

a. All wires connect to controller ok.

b. The controller **stop switch is in the "Stop" or shorted position.**

c. when you connect battery to controller, the LED will light on "00".

Note: Grounding

For long-term operation and protecting the electronics, properly grounding is very important. Grounding procedures must be followed along with any local electrical codes.

The negative wire of your system should be connected to a ground. This is usually done by connecting a wire from the negative battery terminal to a nearby ground rod. Wires with the same ratings as the positive and negative wires must connect all system grounds.

A ground electrode can be made for systems without an existing system ground from an 8 ft. (2.4 m) section of 3/4" (19 mm) galvanized pipe or conduit, or an 8 ft. (2.4 m) section of 5/8" (16 mm) iron or steel rod. This ground electrode must be buried completely beneath the soil, at no more than 45 degrees from vertical, or horizontally at least 2 1/2 ft. (75 cm) beneath the surface. It is recommended that the ground electrode be installed as close as possible to the batteries for maximum lightning protection. The base of the tower is also a good location for an appropriate surge arrestor.

Caution: Improper Grounding Will Damage Your Wind Generator And Void Your Warranty.

10) Carefully raise the tower and secure base and/or guy cables.

Caution: Ensure That The Tower Is Vertical So That The Wind Generator Can Yaw (turn Into The Wind) Properly.

CONGRATULATIONS! You have completed the installation process now.

7. Warranty policy proof of purchase is required(Receipt)

Nature Power Wind Turbines are warranted for a 2 year period. Against defective parts or manufactures workmanship.

What is NOT Covered

- Damage from lightening.
- Damage due to extreme winds (110MPH +).
- Damage from improper installation (Including poor tower design and inverted hanging) Damage from improper wiring.
- Damage to blades from debris.

Any and All modifications to the unit, not stated in this manual

No one has the authority to add to or vary this limited warranty, or to create any other obligations in connection to Nature Power and its products. Any implied warranty is limited to the duration that is stated on this manual. Nature Power will not be liable for damages that any person or property might suffer as a result to the breach and or implied warranty. This warranty applies to the original purchaser.

Customer's Responsibilities:

- Any modifications to the wind turbine will void the warranty and compromise the safety of this machine.
- This Wind turbine must be installed an operated in accordance to the owner's manual and local codes.
- If necessary, all cost of shipping/handling to Nature Power will be the responsibility of the customer.

7.1 ELEVATION

An important fact to keep in mind is elevation. The higher a Wind Generator is from sea level, the lower the air density. Air density is directly proportional to the output of your Wind Generator. Here are some general numbers to keep in mind when determine the maximum output that can be expected from a Wind Generator.

FEET	METER	OUTPUT POWER
1-500ft	0-150m	100%
500-1,000ft	150-300m	97%
1,000-2,000ft	300-600m	94%
2,000-3,000ft	600-900m	91%
3,000-4,000ft	900-1,200m	88%
4,000-5,000ft	1,200-1,500m	85%
5,000-6,000ft	1,500-1,800m	82%
6,000-7,000ft	1,800-2,100m	79%
7,000-8,000ft	2,100-2,400m	76%
8,000-9,000ft	2,400-2,700m	73%
9,000-10,000ft	2,700-3,000m	70%

8. SPECIFICATIONS

MODEL Nemo400	Nature Power Marine Grade 400 Watt Wind Turbine
UPC	839290007068
ROTOR DIAMETER	47.2 Inches
WEIGHT	12.3 lbs
START UP WIND SPEED	7.0MPH or 3.13m/s
VOLTAGE	12VDC and 24VDC
MAXIMUM WIND SPEED	110 MPH
RATED POWER	400 Watts at 28 MPH/ 12.5 m/s Wind Speed
TURBINE CONTROLLER	External Controller - Wind Generator Controller
BLADES	Carbon Fibre Composite
BODY	Cast Aluminum with marine powder coating
POLE DIMENSIONS	1.5 Inch in schedule 40 pipe



For more information and questions please contact:

NATURE POWER PRODUCTS

1-800-588-0590

INFO@NATUREPOWERPRODUCTS.COM